

# Miniature Ball Bearings



---

# Miniature Ball Bearings

---

CAT. NO. E126h

## **Introduction to revised Miniature Ball Bearing catalog (CAT. No. E 126h)**

We want to thank you for your interest in this edition of our miniature ball bearing catalog. It has been revised with our customers in mind, and we hope it fills your needs.

Recently, technology has been advancing at a remarkable pace, and with it has come a host of new products in many fields including computers, office automation, audio-visual equipment, medical equipment, and many others. These striking innovations present a challenge to bearing manufacturers since there are ever increasing demands to offer bearings with higher performance, accuracy, and reliability. Manufacturers of diverse equipment have many different bearing requirements including higher speeds, less torque, less noise and vibration, zero maintenance, survival in harsh environments, integration into units, and many more.

This catalog was revised to reflect certain revisions in JIS and ISO, and to better serve our customers. The first half contains technical information about bearing life, load ratings, limiting speeds, accuracy, lubrication, etc. to facilitate selection of the most appropriate bearing.

The second half presents extensive tables containing most bearing numbers and showing dimensions and pertinent design data listed in the order of increasing bore size. Data in the tables are given in both the International Unit System (SI) and Engineering Unit System (Gravitational System of Units).

We hope this catalog will allow you to select the optimum bearing for your application. However, if assistance is required, please contact NSK and we engineers will quickly supply the information you need.



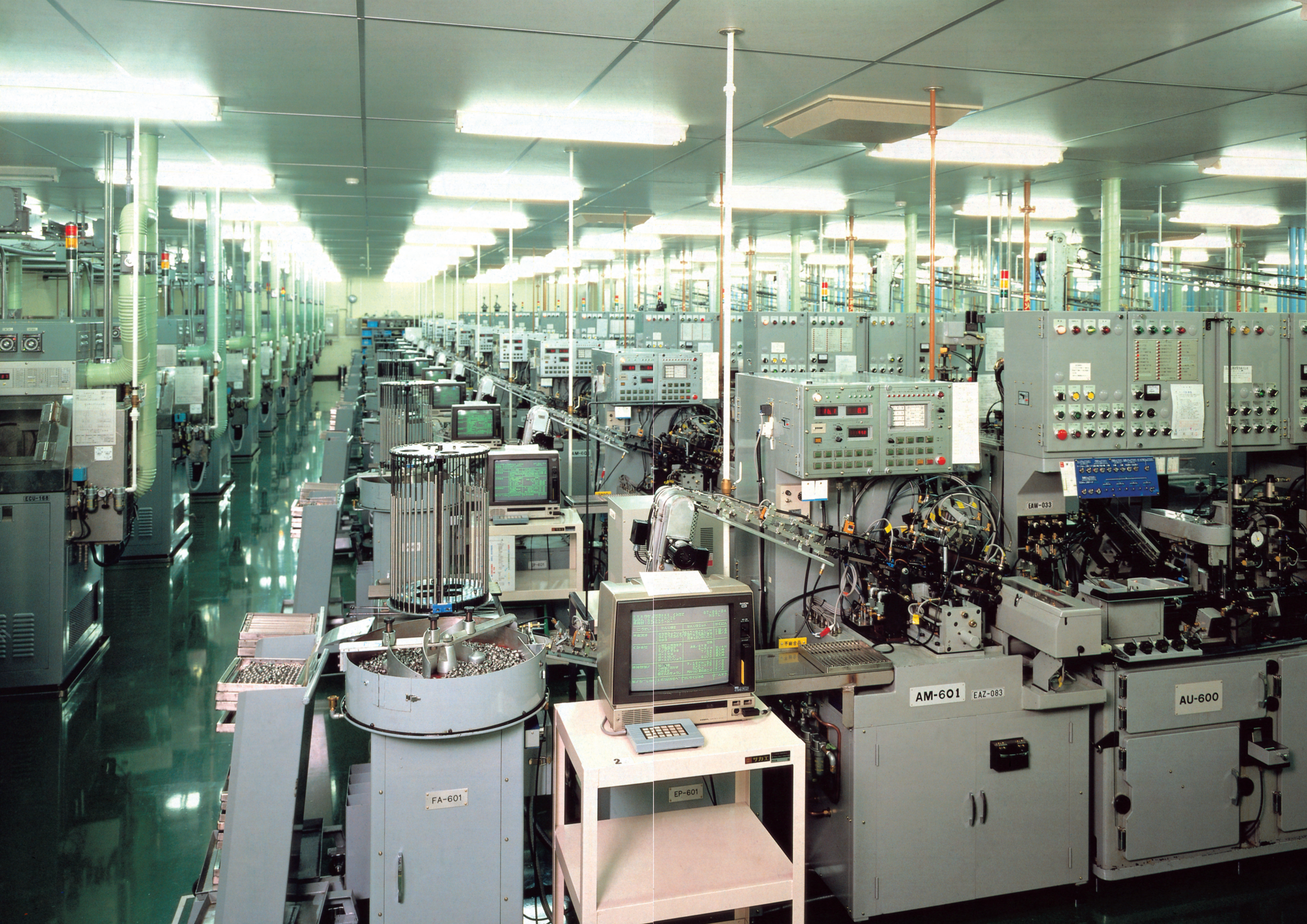



## Contents

### Technical information

	Page
<b>1. Bearing types and features</b> .....	8
<b>2. Formulation of bearing numbers</b> .....	12
<b>3. Cage design</b> .....	14
<b>4. Selection of bearing size</b> .....	14
4.1 Bearing life .....	14
4.2 Basic load rating and fatigue life .....	14
4.3 Static load rating and static equivalent load .....	16
<b>5. Limiting speeds</b> .....	17
<b>6. Bearing tolerances</b> .....	17
<b>7. Fits and internal clearances</b> .....	22
7.1 Shaft and housing fits .....	22
7.2 Bearing internal clearances .....	25
<b>8. Lubrication</b> .....	26
8.1 Purposes of lubrication .....	26
8.2 Lubricating methods and lubricants .....	26
<b>9. Bearing materials</b> .....	28

### Bearing tables

	Page
<b>Contents</b> .....	31

### Appendices

<b>Contents</b> .....	53
Appendix 1 Conversion from SI (International Units) system .....	54
Appendix 2 N – Kgf conversion table .....	56
Appendix 3 Kg – lb conversion table .....	57
Appendix 4 °C – °F conversion table .....	58
Appendix 5 Viscosity conversion table .....	59
Appendix 6 Inch – mm conversion table .....	60
Appendix 7 Hardness conversion table .....	61
Appendix 8 Values of standard tolerances grades IT .....	62
Appendix 9 Physical and mechanical properties of materials .....	64

### Bearing conversion tables

<b>Contents</b> .....	65
-----------------------	----



# 1. Bearing types and features

Miniature and instrument ball bearings can be divided into two basic types, deep groove and angular contact. The first (deep groove) can be further divided into the following five classes depending on their design details:

- Standard type
- Flanged outer ring
- Extended inner ring
- Expanded type in which one ring has a radial thickness

that is larger than normal compared with the bearing width.

- Thin section type in which both rings are extra thin in the radial direction.

Deep groove ball bearings can also be classified as “Open”, “Shielded”, or “Sealed” depending on the existence and type of seal or shield. The size ranges of extra small and miniature ball bearings are shown in **Table 1.1**.

Table 1.1 Size ranges of bearings Units: mm

Design	Extra small ball bearings		Miniature ball bearings	
Metric	Outside diameter	$D \geq 9$	Outside diameter	$D < 9$
	Bore diameter	$d < 10$		
Inch	Outside diameter	$D \geq 9.525$	Outside diameter	$D < 9.525$
	Bore diameter	$d < 10$		

## (1) Single-row deep groove ball bearings

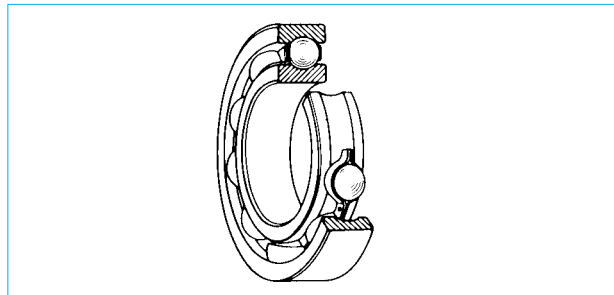

Deep groove ball bearings have two inherent advantages; they can sustain some axial load in either direction as well as radial loads, and the two raceway cross-sections are simple circular arcs which can be very precisely finished so the bearings have low friction and very little noise or vibration. Several different cage designs are available with different characteristics and the choice depends upon the individual application.

## (2) Deep groove ball bearings with flanged outer rings

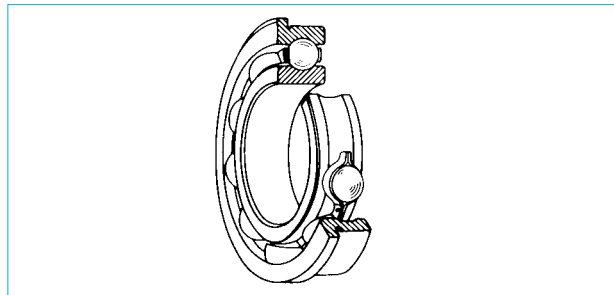

Deep groove ball bearings with flanged outer rings correspond to ordinary ball bearings with snap rings. The flange extends around the entire circumference of the outer ring due to the size limitation and to improve its running accuracy. Since it is not necessary to provide a shoulder on the housing bore if this bearing is used, the bore can be a simple cylindrical shape which facilitates high precision machining and also reduces the machining time.

## (3) Deep groove ball bearings with extended inner rings

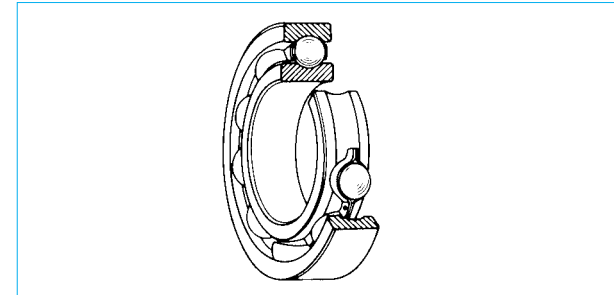

Deep groove ball bearings with extended inner rings are inch series bearings with their inner rings extended equally on both sides by 1/64 inch (0.0156 inch, 0.397 mm) beyond the width of the outer ring. Since the inner ring is therefore wider by 1/32 inch than the outer ring, it is not necessary to provide a projection on parts installed in contact with the inner ring. This feature simplifies the design and fabrication of parts immediately surrounding the bearing.

## (4) Deep groove ball bearings for synchros

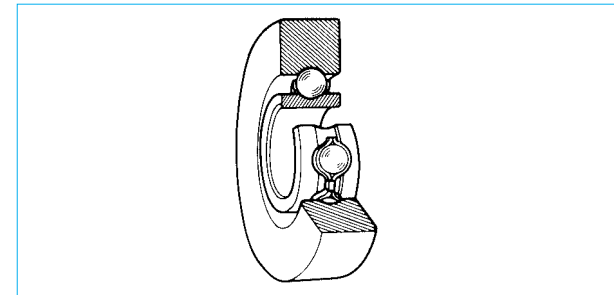

Ball bearings for synchros are inch series bearings with their outer rings thickened radially. Their outer diameter is, therefore, large relative to the bore diameter. These bearings are mainly used for synchros but are convenient in some other applications.

## (5) Extra-thin-section deep groove ball bearings

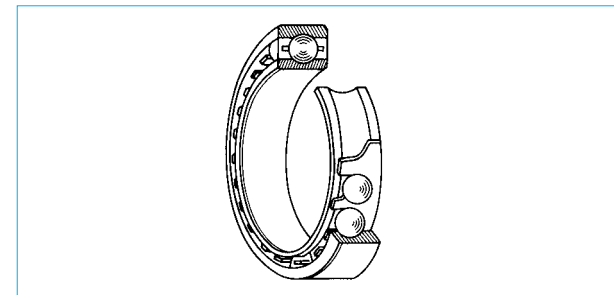

Extra-thin-section deep groove ball bearings have a small radial cross-sectional thickness. NSK offers such bearings with bore diameters from 10 to 15 mm. They are used when extreme compactness is important.



(6) Shielded and sealed bearings

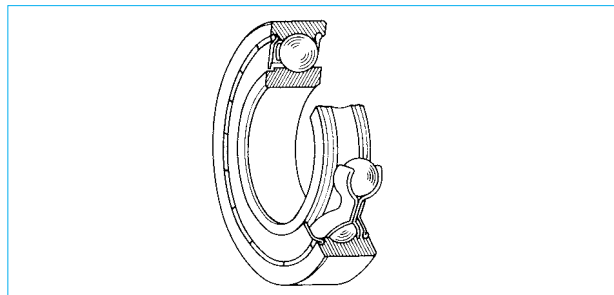

Deep groove ball bearings often have shields or seals installed on both sides and are factory-packed with a lubricant. The use of such bearings simplifies the structure around them and also their installation. It also eliminates the need for relubrication and, therefore, reduces maintenance costs. There are three types of such bearings: shielded bearings, contact sealed bearings, and non-contact sealed bearings.

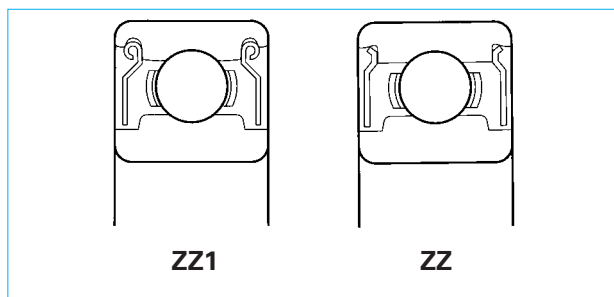

**(a) Shielded bearings ZZ1 (Z1), ZZ (Z)**  
Shielded bearings are protected by a shield plate of pressed steel. The shields can be made of either low carbon steel or stainless steel.

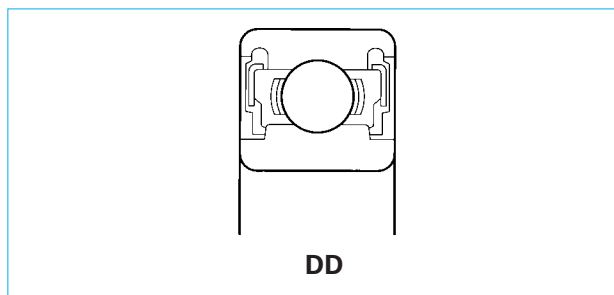

**(b) Contact sealed bearings DD (D)**  
Sealed bearings have superior sealing effectiveness compared to shielded bearings, particularly, the contact type sealed bearings which prevent the intrusion of dust from outside because the seal plate lip slides on a seal groove in the inner ring. The torque is, however, high due to the friction of the seal lip.

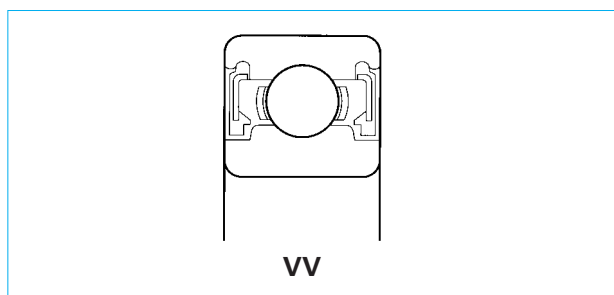

**(c) Non-contact sealed bearings VV (V)**  
With this VV type, a rubber seal with metal backing is held in the outer ring by the elasticity of the rubber. Effective sealing is achieved by a labyrinth formed between its bore and the seal groove in the inner ring. It has the advantage that the frictional torque is low because the seal lip does not contact the seal groove.

(7) Single-row angular contact ball bearings

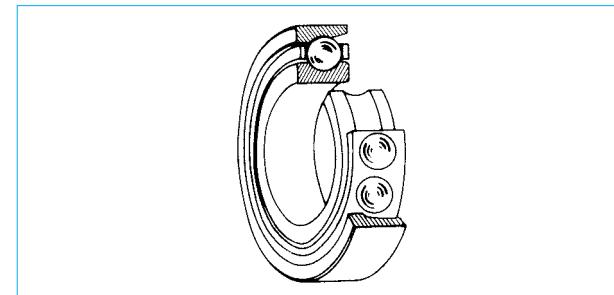

Angular contact ball bearings can sustain radial loads and axial loads in only one direction. Those with one shoulder on the outer ring are generally used, but for extra-high speed operation, bearings with one shoulder on the inner ring are available. Angular contact ball bearings must be used in duplex pairs with a suitable preload. They are recommended for applications requiring high speed and rigidity.



## 2. Formulation of bearing numbers

Bearing numbers are alphanumeric combinations that indicate the bearing type, boundary dimensions, internal clearance, dimensional and running accuracies, and other related specifications. They consist of basic numbers and supplementary symbols. The boundary dimensions of commonly used bearings mostly conform to the organizational concept of ISO, and the bearing numbers of these standard bearings are specified by JIS B 1513 (Designation for rolling bearings). Due to a need for more detailed classification,

NSK uses auxiliary symbols other than those specified by JIS. Basic numbers, supplementary symbols, and the meanings of common numbers and symbols are listed in **Table 2.1** (Pages 12 and 13). The contact angle symbols and other supplementary designations are shown in successive columns from left to right in **Table 2.1**. For reference, five examples of bearing numbers are shown on Page 13.

### Examples of bearing numbers

- (1) 68 1X □ □ □ □ T12 ZZ MC3 □ P4 L UC3 AF2 Q → 681XT12ZZMC3P4LUC3 AF2Q
- (2) 62 4 □ □ □ □ h □ ZZ MC2 E P5 □ □ NS7 L → 624hZZMC2EP5 NS7L
- (3) SMR □ 84 □ □ □ □ W ZZ MC3 □ P5 □ UC1 PS2 L → SMR84WZZMC3P5UC1 PS2L
- (4) SMF □ 148 □ □ □ □ J □ MC4 □ P5 L □ □ □ → SMF148JMC4P5L
- (5) SR □ 2 □ □ □ □ J ZZ MC3 □ 7P □ □ NS7 K → SR2JZZMC37P NS7K

Table 2.1 Formulation of bearing numbers

Basic numbers				Supplementary number																																																																													
Bearing series symbols		Bore number or size number		Contact angle symbol		Internal design symbol		Material symbol		Cage symbol		Seals, shields symbol		Internal clearance symbol		Noise level symbol		Accuracy class symbol		Torque symbol		Special specification symbol		Lubricant symbol		Lubricant quantity symbol																																																							
Symbol	Meaning	Number	Meaning	Symbol	Meaning	Symbol	Meaning	Symbol	Meaning	Symbol	Meaning	Symbol	Meaning	Symbol	Meaning (radial clearance)	Symbol	Meaning	Symbol	Meaning	Symbol	Meaning	Symbol	Meaning	Symbol	Meaning	Symbol	Meaning																																																						
<b>68</b> <b>69</b> <b>60</b> <b>62</b> <b>63</b>	Single-row deep groove ball bearings	<b>1</b>	Bearing bore 1 mm	(Angular contact ball bearings)	<b>A</b>	<b>A</b>	Internal design differs from standard one	Omitted	High carbon chromium bearing steel SUJ 2 Equivalent to ASTM A295 52100	<b>J</b> (Omitted)	Pressed steel ribbon cage	<b>Z</b> <b>Z1</b>	Shield on one side only	<b>MC1</b>	Clearance less than MC2	Omitted	Standard	Omitted	Normal	Omitted	Standard	<b>U1</b>	Special specification	<b>AF2</b>	AEROSHELL FLUID 12	<b>Q</b>	Oil soaking																																																						
<b>2</b>		Bearing bore 2 mm	<b>A5</b>																									Standard contact angle of 25°	<b>h</b>	Stainless steel Equivalent to SAE J405 51440C	<b>W</b> (Omitted)	Pressed steel snap cage	<b>D</b>	Contact rubber seal on one side only	<b>MC2</b>	Clearance less than MC3	<b>E</b>	Quieter than standard	<b>P6</b>	Class 6	<b>L</b>	Low torque	<b>U2</b> ⋮	<b>NS7</b>	NS HI-LUBE	<b>K</b>	Grease packed less than L																																		
<b>3</b>		Bearing bore 3 mm																																														<b>B</b>	Standard contact angle of 40°	<b>S</b>	Stainless steel for special metric and inch designs "S" is prefix to series symbol	<b>T12</b> <b>T1X</b>	Plastic snap cage	<b>DD</b>	Contact rubber seal on both side	<b>MC3</b>	Upgrade normal clearance	<b>ER</b>	Quieter than E	<b>P5</b>	Class 5	<b>UC1</b>	Bore diameter is sorted into two groups	<b>PS2</b>	MULTEMP PS No.2	<b>L</b>	Standard grease packing quantity														
⋮		⋮																																																																		<b>C</b>	Standard contact angle of 15°	<b>W</b>	Plastic snap cage	<b>DD</b>	Contact rubber seal on both side	<b>MC4</b>	Clearance greater than MC4	<b>3</b>	ANSI/ABMA ABEC 3	<b>UC2</b>	Outside diameter is sorted into two groups	<b>S</b>	Grease packed more than L
<b>F68</b> <b>F69</b> <b>F60</b> <b>F62</b> <b>F63</b>		Deep groove ball bearings with flanged outer rings																																																																															
<b>70</b> <b>72</b>	Single-row angular contact ball bearings	<b>2X</b>	Bearing bore 2.5 mm	<b>7P</b>	ANSI/ABMA Instrument ball bearings inch design CLASS 7P	<b>M</b>	Grease packed more than H																																																																										
<b>MR</b>	Single-row deep groove ball bearings	<b>84</b>	Brg O.D. 8 mm Brg bore 4 mm					<b>9P</b>	ANSI/ABMA Instrument ball bearings inch design CLASS 9P	<b>When selecting these specifications please consult NSK</b>																																																																							
<b>MF</b>	Deep groove ball bearings with flanged outer rings	<b>148</b> ⋮	Brg O.D. 14 mm Brg bore 8 mm																																																																														
<b>SMT</b>	Thin-section deep groove ball bearings	<b>41X</b> ⋮	Brg O.D. 4 mm Brg bore 1.2 mm																																																																														
<b>R</b>	Single-row deep groove ball bearings	<b>82X</b> ⋮	Brg O.D. 8 mm Brg bore 2.5 mm																																																																														
<b>SR...X</b>	Ball bearings for synchros	<b>133</b>	Brg O.D. 4.762 mm (3/16 inch) Brg bore 2.380 mm (3/32 inch)																																																																														
<b>RW</b>	Deep groove ball bearings with extended inner rings	<b>155</b>	Brg O.D. 7.938 mm (5/16 inch) Brg bore 3.967 mm (5/32 inch)																																																																														
<b>FRW</b>	Deep groove ball bearings with extended inner rings, flanged	<b>2</b> ⋮	Brg O.D. 9.525 mm (3/8 inch) Brg bore 3.175 mm (1/8 inch)																																																																														



### 3. Cage design

In general, the cages used in miniature bearings are either ribbon cages or snap cages, both made of pressed steel. Pressed steel ribbon cages are generally used in the larger bearings and pressed snap cages in the smaller ones. In recent years, plastic snap cages, which have the advantages of low torque, long grease life, and low noise, have been used in many kinds of miniature ball bearings. **Table 3.1** shows the various types of cages and their symbols.

Table 3.1 Cage types and symbols

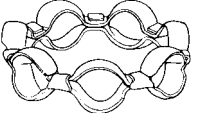
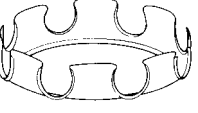
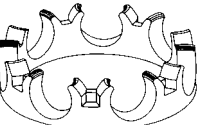
Type	Symbol	Name
	J	Pressed steel ribbon cage
	W	Pressed steel snap cage
	T12 T1X	Plastic snap cage

### 4. Selection of bearing size

#### 4.1 Bearing life

The various functions required of rolling bearings vary according to the bearing application. These functions must be performed for a prolonged period. Even if bearings are properly mounted and correctly operated, they will eventually fail to perform satisfactorily due to an increase in noise and vibration, loss of running accuracy, deterioration of grease, or fatigue flaking of the rolling surfaces.

Bearing life, in the broad sense of the term, is the period during which bearings continue to operate and satisfy their required functions. This bearing life may be defined as noise life, abrasion life, grease life, or rolling fatigue life, depending on which one causes loss of bearing service.

Rolling fatigue life is represented by the total number of revolutions at which time the bearing surface will start flaking due to stress. This is called fatigue life. Even for seemingly identical bearings, which are of the same type, size, and material and receive the same heat treatment and other processing, the rolling fatigue life varies greatly even under identical operating conditions. This is because the flaking of materials due to fatigue is subject to many other variables. Consequently, "rating fatigue life", in which rolling fatigue life is treated as a statistical phenomenon, is used in preference to actual rolling fatigue life.

Suppose a number of bearings of the same type are operated individually under the same conditions. After a certain period of time, 10 % of them fail as a result of flaking caused by rolling fatigue. The total number of revolutions at this point is defined as the rating fatigue life or, if the speed is constant, the rating fatigue life is often expressed by the total number of operating hours completed when 10 % of the bearings become inoperable due to flaking.

#### 4.2 Basic load rating and fatigue life

The basic load rating is defined as the constant load applied on bearings with stationary outer rings that the inner rings can endure for a rating life of one million revolutions ( $10^6$  rev.). The basic load rating of radial bearings is defined as a central radial load of constant direction and magnitude. The load ratings are listed under  $C_r$  for radial bearings in the bearing tables.

In the case of bearings that run at a constant speed, it is convenient to express the fatigue life in terms of hours. The following relation exists between bearing load and rating fatigue life:

$$\text{For radial ball bearings } L = \left(\frac{C}{P}\right)^3 \dots\dots\dots(4.1)$$

where  $L$ : Rating fatigue life ( $10^6$  rev.)  
 $P$ : Bearing load (equivalent load) (N), {kgf}  
 $C$ : Basic load rating (N), {kgf}  
 For radial bearings,  $C$  is written  $C_r$

By designating the rating fatigue life as  $L_h$  (h), bearing speed as  $n$  ( $\text{min}^{-1}$ ), fatigue life factor as  $f_h$ , and speed factor as  $f_n$ , the following relations are obtained:

$$L_h = \frac{10^6}{60n} \left(\frac{C}{P}\right)^3 = 500 f_h^3 \dots\dots\dots(4.2) \text{ (Refer to Fig. 4.2)}$$

$$f_h = f_n \frac{C}{P} \dots\dots\dots(4.3)$$

$$f_n = \left(\frac{10^6}{500 \times 60n}\right)^{\frac{1}{3}} = (0.03n)^{-\frac{1}{3}} \dots\dots\dots(4.4) \text{ (Refer to Fig. 4.1)}$$

If the bearing load,  $P$ , and speed,  $n$ , are known, determine a fatigue life factor,  $f_h$ , appropriate for the projected life of the machine and then calculate the basic load rating,  $C$ , by means of the following equation:

$$C = \frac{f_h \cdot P}{f_n} \dots\dots\dots(4.5)$$

A bearing which satisfies this value of  $C$  should then be selected from the bearing tables. The equivalent load on radial bearings may be calculated using the following equation:

$$P = XF_r + YF_a \dots\dots\dots(4.6)$$

where  $P$ : Equivalent load (N), {kgf}  
 $F_r$ : Radial load (N), {kgf}  
 $F_a$ : Axial load (N), {kgf}  
 $X$ : Radial load factor  
 $Y$ : Axial load factor

The values of  $X$  and  $Y$  are listed in **Table 4.1**.

Table 4.1 Radial and axial load factors

$C_{or}/F_a$	$F_a/F_r \leq e$		$F_a/F_r > e$		$e$
	$X$	$Y$	$X$	$Y$	
5	1	0	0.56	1.26	0.35
10	1	0	0.56	1.49	0.29
15	1	0	0.56	1.64	0.27
20	1	0	0.56	1.76	0.25
25	1	0	0.56	1.85	0.24
30	1	0	0.56	1.92	0.23
50	1	0	0.56	2.13	0.20

Fig. 4.1 Bearing speed and speed factor ( $n - f_n$ )

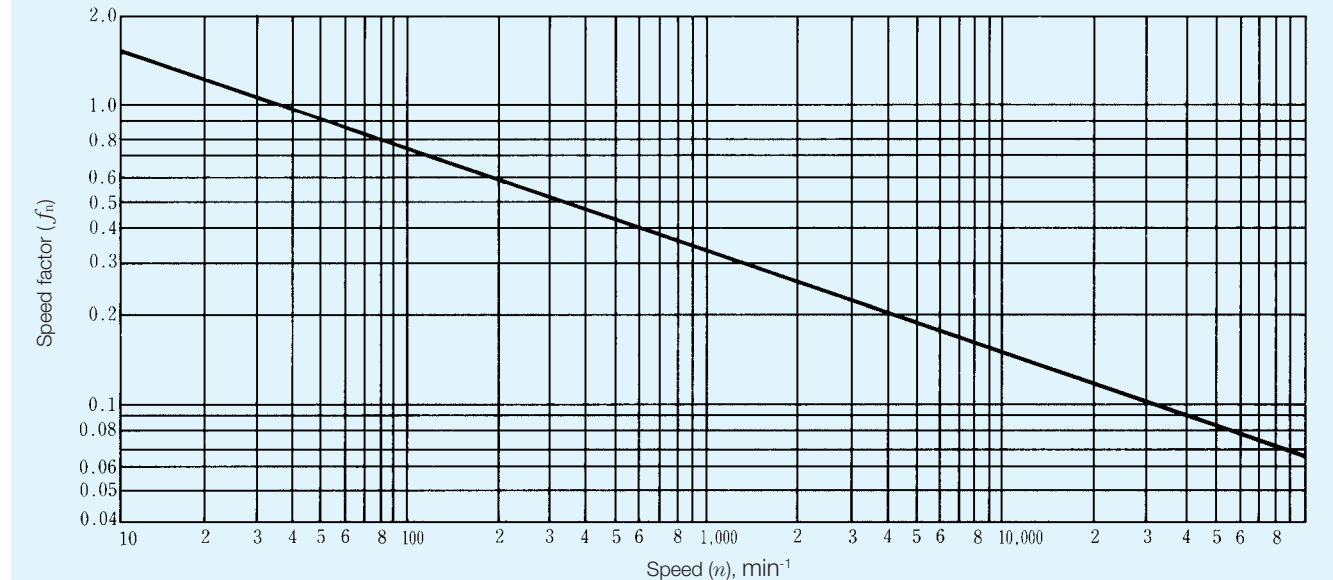
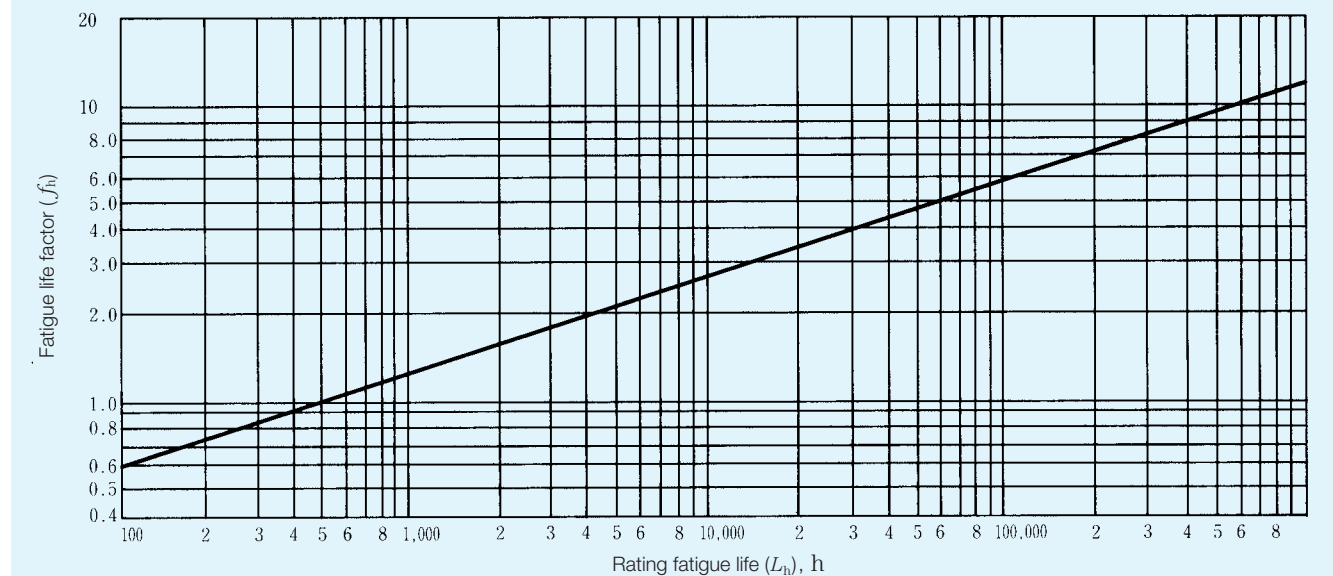

Fig. 4.2 Fatigue life factor and rating fatigue life ( $f_h - L_h$ )





The  $L_{10}$  life is defined as the rating fatigue life with a statistical reliability of 90 %. Depending on the machines in which the bearings are used, sometimes a reliability higher than 90 % may be required. However, recent improvements in bearing material have greatly extended the fatigue life. In addition, the development of the Elasto-Hydrodynamic Theory of Lubrication proves that the thickness of the lubricating film in the contact zone between rings and rolling elements greatly influences bearing life. To reflect such improvements in the calculation of fatigue life, the rating fatigue life is corrected using the following correction factors:

$$L_{na} = a_1 a_2 a_3 L_{10} \dots \dots \dots (4.7)$$

where  $L_{na}$  : Adjusted rating life in which reliability, material improvements, lubricating conditions, etc. are considered

- $L_{10}$  : Rating fatigue life with a reliability of 90 %
- $a_1$  : Life correction factor for reliability
- $a_2$  : Life correction factor for material
- $a_3$  : Life correction factor for operating conditions

The life correction factor for reliability  $a_1$  is listed in **Table 4.2** for reliabilities higher than 90 %.

Table 4.2 Reliability factor  $a_1$

Reliability (%)	90	95	96	97	98	99
$a_1$	1.00	0.62	0.53	0.44	0.33	0.21

The life correction factor for material,  $a_2$ , is greater than one because of improvements in bearing steel. NSK now uses vacuum degassed bearing steel, and the results of tests by NSK show that life is greatly improved when compared with earlier materials. The basic load ratings,  $C_r$ , listed in the bearing tables were calculated considering the extended life achieved by improvements in materials and manufacturing techniques. Consequently, when estimating life using **Equation (4.7)**, it is sufficient to assume  $a_2=1$ .

The life correction factor for operating conditions,  $a_3$ , is used to correct for various factors, particularly lubrication. If there is no misalignment between the inner and outer rings and the thickness of the lubricating film in the contact zones of the bearing is sufficient, it is possible for  $a_3$  to be greater than one; however,  $a_3$  is less than one in the following cases:

- When the viscosity of the lubricant in the contact zones between the raceways and rolling elements is low.
- When the circumferential speed of the rolling elements is very slow.
- When the bearing temperature is high.
- When the lubricant is contaminated by water or foreign matter.
- When misalignment of the inner and outer rings is excessive.

It is difficult to determine the proper value for  $a_3$  for specific operating conditions because there are still many unknowns. Since the material factor  $a_2$  is also influenced by the operating conditions, there is a proposal to combine  $a_2$  and  $a_3$  into one quantity ( $a_2 \times a_3$ ), and not consider them independently. In this case, under normal lubricating and operating conditions, the product ( $a_2 \times a_3$ ) should be assumed equal to one. However, if the viscosity of the lubricant is too low, the value drops to as low as 0.2. If there is no misalignment and a lubricant with high viscosity is used so sufficient fluid-film thickness is secured, the product of ( $a_2 \times a_3$ ) can be set around two.

It is very rare for extra small and miniature ball bearings to fail because of fatigue. Other problems such as wear, reduced accuracy, or deterioration of the grease define the limit of bearing life instead of flaking. This is particularly true of audio-visual equipment in which extra low noise and vibration, low torque, or other requirements are highly important. The elapsed time when a bearing fails to satisfy its functional requirements may be regarded as bearing service life.

### 4.3 Static load rating and static equivalent load

When subjected to an excessive load or a strong shock load, rolling bearings may incur a local permanent deformation of the rolling elements and raceway surface if the elastic limit is exceeded. The nonelastic deformation increases in area and depth as the load increases, and when the load exceeds a certain limit, the smooth running of the bearing is impeded. The basic static load rating for deep groove ball bearings is defined as that static load which produces 4200 MPa {428 kgf/mm<sup>2</sup>} contact stress at the center of the contact area between the rolling element subjected to the maximum stress and the raceway surface.

In this most heavily stressed contact area, the sum of the permanent deformation of the rolling element and that of the raceway is nearly 0.0001 times the rolling element's diameter. The basic static load rating,  $C_o$ , is written "C<sub>or</sub>" for radial bearings in the bearing tables.

The static equivalent load is a hypothetical load that produces a contact stress equal to the above maximum stress under actual conditions, while the bearing is stationary (including very slow rotation or oscillation), in the area of contact between the most heavily stressed rolling element and bearing raceway. The greater of the two values calculated from the following equations should be adopted as the static equivalent load on radial bearings.

$$P_o = X_o F_r + Y_o F_a \dots \dots \dots (4.8)$$

$$P_o = F_r \dots \dots \dots (4.9)$$

- where  $P_o$ : Static equivalent load (N), {kgf}
- $F_r$ : Radial load (N), {kgf}
- $F_a$ : Axial load (N), {kgf}
- $X_o$ : Static radial load factor (0.6)
- $Y_o$ : Static axial load factor (0.5)

The permissible static equivalent load of a bearings varies depending on its basic static load rating and also their application and operating conditions. The permissible static load factor,  $f_s$ , is a safety factor that is applied to the basic static load rating. It is defined by the ratio in **Equation (4.10)**. The generally recommended values of  $f_s$  are listed in **Table 4.3**.

$$f_s = \frac{C_o}{P_o} \dots \dots \dots (4.10)$$

- where  $C_o$ : Basic static load rating (N), {kgf}
- $P_o$ : Static equivalent load (N), {kgf}

Table 4.3 Values of permissible static load factor  $f_s$

Operating conditions of ball bearings	Lower limit of $f_s$
Low-noise applications	2
Bearings subjected to vibration and shock loads	1.5
Standard operating conditions	1

## 5. Limiting speeds

The speed of rolling bearings is subject to certain limits. When bearings are operating, the higher the speed, the higher the bearing temperature due to friction. The limiting speed is the empirically obtained value for the maximum speed at which bearings can be continuously operated without failing from seizure or generation of excessive heat. Consequently, the limiting speed of bearings varies depending on such factors as bearing type and size, cage form and material, load, lubrication method, and heat dissipating method including the design of the bearing's surroundings. The maximum permissible speed for contact rubber sealed bearings (DD type) is determined mainly by the sliding surface speed of the inner circumference of the seal.

Values for the limiting speed of bearings lubricated by grease and oil are listed in the bearing tables. The limiting speeds in the tables are applicable to bearings of standard design that are subjected to normal loads, i.e.  $C/P \geq 12$  and  $F_a/F_r \leq 0.2$  approximately. The limiting speeds for oil lubrication listed in the bearing tables are for conventional oil bath lubrication. When speeds are more than 70 percent of the listed limiting speed, it is necessary to select an oil or grease which has good high-speed characteristics. When the required speed exceeds the limiting speed of the desired bearing, then the accuracy grade, internal clearance, cage type and material, and lubrication, must be carefully studied in order to select a bearing capable of the required speed. If all these conditions are considered, the maximum permissible speed may be higher than the limiting speed found in the bearing table. It is recommended that NSK be consulted regarding high-speed applications.

## 6. Bearing tolerances

The tolerances for the boundary dimensions and running accuracy of extra small and miniature ball bearings are specified by ISO 492/582 (Rolling bearings-radial bearings tolerances) and ANSI/ABMA Std. 12.2 (Instrument ball bearings inch design). **Tables 6.1, 6.2** and **6.3** apply to metric design extra small and miniature ball bearings. **Tables 6.4** and **6.5** apply to inch design extra small and miniature precision ball bearings for instruments. Bearing accuracy should be chosen depending on the application. A rough guide for the selection of bearing accuracy is presented in **Table 6.6**.

### Symbols for boundary dimensions and running accuracy

- $d$  Brg bore dia., nominal
- $\Delta_{ds}$  Deviation of a single bore dia.
- $\Delta_{dmp}$  Single plane mean bore dia. deviation
- $V_{dp}$  Bore dia. variation in a single radial plane
- $V_{dmp}$  Mean bore dia. variation
- $D$  Brg outside dia., nominal
- $\Delta_{Ds}$  Deviation of a single outside dia.
- $\Delta_{Dmp}$  Single plane mean outside dia. deviation
- $V_{Dp}$  Outside dia. variation in a single radial plane
- $V_{Dmp}$  Mean outside dia. variation
- $D_1$  Outside dia. of the outer ring flange, nominal
- $\Delta_{D1s}$  Deviation of a single outside diameter of the outer ring flange
- $B$  Inner ring width, nominal
- $\Delta_{Bs}$  Deviation of a single inner ring width
- $V_{Bs}$  Inner ring width variation
- $C$  Outer ring width, nominal
- $\Delta_{Cs}$  Deviation of a single outer ring width
- $V_{Cs}$  Outer ring width variation
- $C_1$  Outer ring flange width, nominal
- $\Delta_{C1s}$  Deviation of a single outer ring flange width
- $V_{D1s}$  Outer ring flange width variation
- $K_{ia}$  Radial runout of assembled brg. inner ring
- $K_{ea}$  Radial runout of assembled brg. outer ring
- $S_d$  Inner ring reference face (backface, where applicable) runout with bore
- $S_{ia}$  Assembled brg. inner ring face (backface) runout with raceway
- $S_D$  Variation of brg. outside surface generatrix inclination with outer ring reference face (backface)
- $S_{ea}$  Assembled brg. outer ring face (backface) runout with raceway
- $S_{ea1}$  Assembled brg. outer ring flange back face runout with raceway



Table 6.1 Tolerances and tolerance limits for inner rings and widths of outer rings (Metric design)

Nominal bore diameter $d$ (mm)		$\Delta_{dmp}$										$\Delta_{ds}$				$V_{dp}$										$V_{dmp}$						
		Normal		Class 6		Class 5		Class 4		Class 2		Class 4		Class 2		Normal			Class 6			Class 5		Class 4		Class 2		Normal	Class 6	Class 5	Class 4	Class 2
												Diameter series				Diameter series			Diameter series		Diameter series											
												0, 2, 3				9	0	2, 3	9	0	2, 3	9	0, 2, 3	9	0, 2, 3							
over	incl.	high	low	high	low	high	low	high	low	high	low	high	low	high	low	max.	max.	max.	max.	max.	max.	max.	max.	max.	max.	max.	max.	max.	max.			
<b>0.6<sup>(1)</sup></b>	<b>2.5</b>	0	-8	0	-7	0	-5	0	-4	0	-2.5	0	-4	0	-2.5	10	8	6	9	7	5	5	4	4	3	2.5	6	5	3	2	1.5	
<b>2.5</b>	<b>10</b>	0	-8	0	-7	0	-5	0	-4	0	-2.5	0	-4	0	-2.5	10	8	6	9	7	5	5	4	4	3	2.5	6	5	3	2	1.5	
<b>10</b>	<b>18</b>	0	-8	0	-7	0	-5	0	-4	0	-2.5	0	-4	0	-2.5	10	8	6	9	7	5	5	4	4	3	2.5	6	5	3	2	1.5	

Units:  $\mu\text{m}$

$\Delta_{Bs}$ (or $\Delta_{Cs}$ ) <sup>(2)</sup>												$V_{Bs}$ (or $V_{Cs}$ ) <sup>(2)</sup>					$K_{ia}$					$S_d$			$S_{ia}$			Nominal bore diameter $d$ (mm)		
Single bearing						Combined bearings <sup>(3)</sup>						Inner ring (or outer ring) <sup>(2)</sup>					Normal					Class 5			Class 4					
Normal Class 6		Class 5 Class 4		Class 2		Normal Class 6		Class 5 Class 4		Normal		Class 6		Class 5		Class 4		Class 2		Class 5			Class 4			Class 2				
high	low	high	low	high	low	high	low	high	low	high	low	high	low	high	low	high	low	high	low	high	low	high	low	high	low	high	low			high
0	-40	0	-40	0	-40	—	—	0	-250	12	12	5	2.5	1.5	10	5	4	2.5	1.5	7	3	1.5	7	3	1.5	7	3	1.5	0.6 <sup>(1)</sup>	2.5
0	-120	0	-40	0	-40	0	-250	0	-250	15	15	5	2.5	1.5	10	6	4	2.5	1.5	7	3	1.5	7	3	1.5	7	3	1.5	2.5	10
0	-120	0	-80	0	-80	0	-250	0	-250	20	20	5	2.5	1.5	10	7	4	2.5	1.5	7	3	1.5	7	3	1.5	7	3	1.5	10	18

Notes <sup>(1)</sup> 0.6 mm is included in the group.

<sup>(2)</sup> Tolerances for width deviation and width dimensional variation of the outer ring are based on the values for the inner ring of the same bearing. Tolerance for the width variation of the outer ring of Class 5, 4 and 2 are shown in **Table 6.2**.

<sup>(3)</sup> Applicable to individual rings manufactured for combined bearings.

Remarks 1. The cylindrical bore diameter "no-go side" tolerance limit (high) specified in this table does not necessarily apply within a distance of 1.2 times the chamfer dimension  $r(\text{max.})$  from the ring face.  
2. ANSI/ABMA Std. 20-1996: ABEC1, ABEC3, ABEC5, ABEC7, and ABEC9 are equivalent to Classes Normal, 6, 5, 4 and 2, respectively.

Table 6.2 Tolerances and tolerance limits for outer rings (Metric design)

Nominal outside diameter $D$ (mm)		$\Delta_{Dmp}$										$\Delta_{Ds}$				$V_{Dp}$										$V_{Dmp}$									
		Normal		Class 6		Class 5		Class 4		Class 2		Class 4		Class 2		Normal			Class 6			Class 5		Class 4		Class 2		Normal	Class 6	Class 5	Class 4	Class 2			
												Diameter series				Open type			Shielded sealed		Open type		Shielded sealed		Open type								Open type		
												0, 2, 3				9	0	2, 3	2, 3	9	0	2, 3	0, 2, 3	9	0, 2, 3								9	0, 2, 3	
over	incl.	high	low	high	low	high	low	high	low	high	low	high	low	high	low	max.	max.	max.	max.	max.	max.	max.	max.	max.	max.	max.	max.	max.	max.	max.					
<b>2.5<sup>(1)</sup></b>	<b>6</b>	0	-8	0	-7	0	-5	0	-4	0	-2.5	0	-4	0	-2.5	10	8	6	10	9	7	5	9	5	4	4	3	2.5	6	5	3	2	1.5		
<b>6</b>	<b>18</b>	0	-8	0	-7	0	-5	0	-4	0	-2.5	0	-4	0	-2.5	10	8	6	10	9	7	5	9	5	4	4	3	2.5	6	5	3	2	1.5		
<b>18</b>	<b>30</b>	0	-9	0	-8	0	-6	0	-5	0	-4	0	-5	0	-4	12	9	7	12	10	8	6	10	6	5	5	4	4	7	6	3	2.5	2		

Units:  $\mu\text{m}$

Nominal outside diameter $D$ (mm)		$K_{ea}$					$S_D$			$S_{ea}$ (or $S_{eal}$ ) <sup>(2)</sup>			$V_{Cs}$ <sup>(3)</sup>		
		Normal	Class 6	Class 5	Class 4	Class 2	Class 5	Class 4	Class 2	Class 5	Class 4	Class 2	Class 5	Class 4	Class 2
over	incl.	max.	max.	max.	max.	max.	max.	max.	max.	max.	max.	max.	max.	max.	
<b>2.5<sup>(1)</sup></b>	<b>6</b>	15	8	5	3	1.5	8	4	1.5	8	5	1.5	5	5	1.5
<b>6</b>	<b>18</b>	15	8	5	3	1.5	8	4	1.5	8	5	1.5	5	5	1.5
<b>18</b>	<b>30</b>	15	9	6	4	2.5	8	4	1.5	8	5	2.5	5	5	1.5

Notes <sup>(1)</sup> 2.5 mm is included in the group.

<sup>(2)</sup> Applicable to assembled-bearing flange backface runout with raceway.

<sup>(3)</sup> The tolerances for outer ring width variation of bearings of Class Normal and 6 are shown in **Table 6.1**.

Remarks 1. The outside diameter "no-go-side" tolerance (low) specified in this table does not necessarily apply within a distance of 1.2 times the chamfer dimension  $r(\text{max.})$  from the ring face.  
2. ANSI/ABMA Std. 20-1996: ABEC1, ABEC3, ABEC5, ABEC7, and ABEC9 are equivalent to Classes Normal, 6, 5, 4 and 2, respectively.

Table 6.3 Flange tolerances for metric flanged bearings

(1) Tolerances of outside diameter flange

Units:  $\mu\text{m}$

Nominal flange outside diameter $D_1$ (mm)		Deviation of outside diameter flange $\Delta_{Dis}$	
over	incl.	high	low
—	<b>10</b>	+220	-36
<b>10</b>	<b>18</b>	+270	-43
<b>18</b>	<b>30</b>	+330	-52

Remarks When the tolerance not shown in the table above, please contact NSK.



(2) Flange width tolerances and running accuracies related to flange

Units:  $\mu\text{m}$

Nominal bearing outside diameter $D$ (mm)		Deviation of flange width $\Delta_{Cl_s}$		Variation of flange width $\Delta_{Cl_s}$				Variation of brg outside surface generatrix inclination with flange backface $S_{D1}$			Flange backface runout with raceway $S_{eal}$		
				$V_{Cl_s}$				Class 5, Class 4, Class 2			Class 5, Class 4, Class 2		
over	incl.	high	low	max.				max.			max.		
2.5 <sup>(1)</sup>	6	Use the $\Delta_{Bs}$ tolerance for $d$ of the same bearing of the same class		Use the $V_{Bs}$ tolerance for $d$ of the same bearing of the same class	5	2.5	1.5	8	4	1.5	11	7	3
6	18				5	2.5	1.5	8	4	1.5	11	7	3
18	30				5	2.5	1.5	8	4	1.5	11	7	3

Note <sup>(1)</sup> 2.5 mm is included.

Table 6.4 Tolerances and tolerance limits for inner rings and widths of outer rings (ANSI/ABMA Standard • Instrument ball bearings • inch design)

Units:  $\mu\text{m}$

Nominal bore diameter $d$ (mm)		$\Delta_{dmp}$		$\Delta_{ds}$		$V_{dp}$		$V_{dmp}$		$\Delta_{Bs}$ (or $\Delta_{Cs}$ )				$V_{Bs}$			$K_{ia}$			$S_{ia}$			$S_d$						
		CLASS 5P CLASS 7P	CLASS 9P	CLASS 5P CLASS 7P	CLASS 9P	CLASS 5P CLASS 7P	CLASS 9P	CLASS 5P CLASS 7P	CLASS 9P	CLASS 5P CLASS 7P CLASS 9P	CLASS 5P CLASS 7P CLASS 9P	CLASS 5P	CLASS 7P	CLASS 9P	CLASS 5P	CLASS 7P	CLASS 9P	CLASS 5P	CLASS 7P	CLASS 9P	CLASS 5P	CLASS 7P	CLASS 9P						
over	incl.	high	low	high	low	high	low	high	low	max.	max.	max.	max.	high	low	high	low	max.	max.	max.	max.	max.	max.	max.	max.	max.	max.	max.	
—	10	0	-5.1	0	-2.5	0	-5.1	0	-2.5	2.5	1.3	2.5	1.3	0	-25.4	0	-400	5.1	2.5	1.3	3.8	2.5	1.3	7.6	2.5	1.3	7.6	2.5	1.3
10	18	0	-5.1	0	-2.5	0	-5.1	0	-2.5	2.5	1.3	2.5	1.3	0	-25.4	0	-400	5.1	2.5	1.3	3.8	2.5	1.3	7.6	2.5	1.3	7.6	2.5	1.3
18	30	0	-5.1	0	-2.5	0	-5.1	0	-2.5	2.5	1.3	2.5	1.3	0	-25.4	0	-400	5.1	2.5	1.3	3.8	2.5	2.5	7.6	3.8	1.3	7.6	3.8	1.3

Note <sup>(1)</sup> Applicable to bearings for which the axial clearance (preload) is to be adjusted by combining two selected bearings.

Remarks CLASSES 5P, 7P and 9P are for precision bearings for instruments.

For the tolerances of Metric Design Precision Bearings for instruments, it is advisable to consult NSK.

Table 6.5 Tolerances and tolerance limits for outer rings (ANSI/ABMA Standard • Instrument ball bearings • inch design)

Units:  $\mu\text{m}$

Nominal outside diameter $D$ (mm)		$\Delta_{Dmp}$		$\Delta_{Ds}$				$V_{Dp}$		$V_{Dmp}$			$V_{Cs}$ <sup>(1)</sup>			$S_D$			$K_{ea}$			$S_{ea}$			$\Delta_{Dls}$		$\Delta_{Cl_s}$		$S_{eal}$ <sup>(2)</sup>					
		CLASS 5P CLASS 7P	CLASS 9P	CLASS 5P CLASS 7P		CLASS 9P	CLASS 5P CLASS 7P	CLASS 9P	CLASS 5P CLASS 7P	CLASS 9P	CLASS 5P CLASS 7P	CLASS 9P	CLASS 5P	CLASS 7P	CLASS 9P	CLASS 5P	CLASS 7P	CLASS 9P	CLASS 5P	CLASS 7P	CLASS 9P	CLASS 5P	CLASS 7P	CLASS 9P	CLASS 5P	CLASS 7P	CLASS 9P	CLASS 5P	CLASS 7P	CLASS 9P				
over	incl.	high	low	high	low	high	low	high	low	max.	max.	max.	max.	max.	max.	max.	max.	max.	max.	max.	max.	max.	max.	max.	max.	max.	max.	max.	max.	max.				
—	18	0	-5.1	0	-2.5	0	-5.1	+1	-6.1	0	-2.5	2.5	5.1	1.3	2.5	5.1	1.3	5.1	2.5	1.3	7.6	3.8	1.3	5.1	3.8	1.3	7.6	5.1	1.3	0	-25.4	0	-50.8	7.6
18	30	0	-5.1	0	-3.8	0	-5.1	+1	-6.1	0	-3.8	2.5	5.1	2	2.5	5.1	2	5.1	2.5	1.3	7.6	3.8	1.3	5.1	3.8	2.5	7.6	5.1	2.5	0	-25.4	0	-50.8	7.6
30	50	0	-5.1	0	-3.8	0	-5.1	+1	-6.1	0	-3.8	2.5	5.1	2	2.5	5.1	2	5.1	2.5	1.3	7.6	3.8	1.3	5.1	5.1	2.5	7.6	5.1	2.5	0	-25.4	0	-50.8	7.6

Notes <sup>(1)</sup> Applicable to flange width variation for flanged bearings, but excluding CLASS 9P.

<sup>(2)</sup> Applicable to flange back face.

Table 6.6 Guide for selection of bearing accuracy

Application	Bearing tolerance classes	
	ISO	ANSI/ABMA
Micro motors, stepping motors, fan motors, VCR pinch rollers, computer printers, copy machine-feed rollers	Normal Class 6	ABEC 1 ABEC 3
High precision motors, hard disk drive motors, dental spindles, servo motors, encoders, VCR drum spindles, VCR capstan motors, polygonal mirror scanner motors	Class 5 Class 4	CLASS 5P CLASS 7P
High frequency spindles, gyro rotors, gyro gimbals	Class 4	CLASS 7P, CLASS 9P

## 7. Fits and internal clearances

### 7.1 Shaft and housing fits

The fitting practice used for bearings is extremely important in achieving their expected performance. Since miniature bearings are usually used under light loads, the range between a push fit (light interference) and a slip fit (slightly loose) is generally used. In the case of a rotating inner ring, ordinary ball bearings are fitted to the shaft with interference, however, a slip fit is

generally used for miniature bearings and instrument ball bearings in order to simplify their mounting, prevent damage during mounting and avoid changing the contact angle or preload. This is because the occurrence of creep in miniature bearings is easily prevented by tightening the side face of the inner ring against a shoulder on the shaft with a nut.

When a spring is used to apply a preload to a bearing, the fitting of the bearing ring in contact with the spring should be loosely fitted so the ring slides smoothly. When housings are built of lightweight alloys, the fitting clearance of the outer ring will increase with increasing temperature and possibly impair the machine's operation and reduce the bearing life; therefore, the bearings should be mounted in a steel bushing.

**Tables 7.1** and **7.2** show the recommended fittings for various design conditions and applications. **Tables 7.3** and **7.4** show allowable tolerances for shafts and housing bores for various size ranges of miniature ball bearings.

Table 7.1 Inner ring fit with shaft

Condition		Application	Bearing tolerance class	Fit	Shaft finish (μm)	Suggested average fit <sup>(1)</sup>	
Rotating inner ring	Low speed	Synchros Servos Potentiometers Resolvers Gyro gimbals	Class 5 Class 4 CLASS 5P CLASS 7P	Slightly loose fit (slip fit)	$\phi d \begin{smallmatrix} -2 \\ -7 \end{smallmatrix}$	2L	
	Low and medium speeds	Fans Small motors	Normal Class 6 ABEC 1 ABEC 3	Transition fit	$\phi d \text{ h}5$	±0	
	Medium and high speeds	Inner ring axially free	Computer disk spindles	Class 5 Class 4 CLASS 5P CLASS 7P	Slightly loose fit <sup>(2)</sup>	$\phi d \begin{smallmatrix} -5 \\ -8 \end{smallmatrix}$	4L
			Video cassette recorder drum spindles		Close-sliding fit	$\phi d \begin{smallmatrix} -1 \\ -6 \end{smallmatrix}$	1L
		Gyro rotors Dental spindles High-frequency spindles	Class 4 CLASS 7P	Slight interference fit (push fit)	$\phi d \pm 2.5$	2T	
		Vacuum cleaners Electric tools	Normal ABEC 1	Light interference fit	$\phi d \text{ js}5$	5T	
		Polygonal mirror scanner motors	Class 5 Class 4 CLASS 5P CLASS 7P	Close-sliding fit	$\phi d \begin{smallmatrix} -1 \\ -6 \end{smallmatrix}$	1L	
Inner ring axially fixed	Gyro rotors		Loose fit	$\phi d \begin{smallmatrix} -5 \\ -10 \end{smallmatrix}$	5L		
Rotating outer ring	Low to high speeds	Inner ring axially free Clutches Small fans	Normal Class 6 ABEC 1 ABEC 3	Loose fit	$\phi d \text{ g}5$	5L	
		Inner ring axially fixed Tape guide rolls Pinch rolls	Class 5 Class 4 CLASS 5P CLASS 7P	Loose fit	$\phi d \begin{smallmatrix} -5 \\ -10 \end{smallmatrix}$	5L	

**Notes** <sup>(1)</sup> L: Loose fit, T: Interference fit  
<sup>(2)</sup> After mounting, usually bonded

Table 7.2 Outer ring fit with housing

Condition		Application	Bearing tolerance class	Fit	Housing finish (μm)	Suggested average fit <sup>(1)</sup>
Rotating inner ring	Low speed	Synchros Servos Potentiometers Resolvers Gyro gimbals	Class 5 Class 4 CLASS 5P CLASS 7P	Slightly loose fit	$\phi D \begin{smallmatrix} +3 \\ -2 \end{smallmatrix}$	2L
	Medium and high speeds	Small motors Electric tools Vacuum cleaners Fan motors	Normal ABEC 1	Loose fit	$\phi D \text{ H}6$	9L
		Computer disk spindles	Class 5 Class 4 CLASS 5P CLASS 7P	Loose fit <sup>(2)</sup>	$\phi D \begin{smallmatrix} +3 \\ 0 \end{smallmatrix}$	4L
		Video cassette recorder drum spindles		Slightly loose fit	$\phi D \begin{smallmatrix} -2 \\ -5 \end{smallmatrix}$	2TL
		Gyro rotors High frequency spindles	Class 5 Class 4 CLASS 5P CLASS 7P	Loose fit	$\phi D \begin{smallmatrix} +5 \\ 0 \end{smallmatrix}$	5L
		Polygonal mirror scanner motors		Loose fit <sup>(2)</sup>	$\phi D \begin{smallmatrix} +3 \\ 0 \end{smallmatrix}$	4L
	Low to high speeds	Tape guide rolls Pinch rolls	Class 5 Class 4 CLASS 5P CLASS 7P	Slightly Loose fit	$\phi D \begin{smallmatrix} +3 \\ -2 \end{smallmatrix}$	2L
Rotating outer ring	Cam followers Tension pulleys Idler gears	Normal Class 6 ABEC 1 ABEC 3	Interference fit	$\phi D \text{ M}5$	5T	

**Notes** <sup>(1)</sup> L: Loose fit, T: Interference fit  
<sup>(2)</sup> After mounting, usually bonded



Table 7.3 Tolerances for shaft diameters

Units:  $\mu\text{m}$

Shaft dia. (mm)		Tolerance class for shafts					
over	incl.	g4	g5	h4	h5	js4	js5
	<b>3</b>	-2 to - 5	-2 to - 6	0 to -3	0 to -4	$\pm 1.5$	$\pm 2$
<b>3</b>	<b>6</b>	-4 to - 8	-4 to - 9	0 to -4	0 to -5	$\pm 2$	$\pm 2.5$
<b>6</b>	<b>10</b>	-5 to - 9	-5 to -11	0 to -4	0 to -6	$\pm 2$	$\pm 3$
<b>10</b>	<b>18</b>	-6 to -10	-6 to -14	0 to -5	0 to -8	$\pm 2.5$	$\pm 4$

Table 7.4 Tolerances for housing bores

Units:  $\mu\text{m}$

Bore dia. (mm)		Tolerance class for housings							
over	incl.	H5	H6	JS5	JS6	K5	K6	M5	M6
	<b>3</b>	+4 to 0	+ 6 to 0	$\pm 2$	$\pm 3$	0 to -4	0 to - 6	-2 to - 6	-2 to - 8
<b>3</b>	<b>6</b>	+5 to 0	+ 8 to 0	$\pm 2.5$	$\pm 4$	0 to -5	+2 to - 6	-3 to - 8	-1 to - 9
<b>6</b>	<b>10</b>	+6 to 0	+ 9 to 0	$\pm 3$	$\pm 4.5$	+1 to -5	+2 to - 7	-4 to -10	-3 to -12
<b>10</b>	<b>18</b>	+8 to 0	+11 to 0	$\pm 4$	$\pm 5.5$	+2 to -6	+2 to - 9	-4 to -12	-4 to -15
<b>18</b>	<b>30</b>	+9 to 0	+13 to 0	$\pm 4.5$	$\pm 6.5$	+1 to -8	+2 to -11	-5 to -14	-4 to -17

If the accuracy of a shaft or housing does not meet the specification, the performance of the bearings will be affected and they will not perform to their full capability. For example, inaccuracy in the squareness of the shaft shoulder may cause misalignment of the bearing inner and outer rings, which may reduce the bearing fatigue life by adding an edge load in addition to the normal load. Cage fracture and seizure sometimes occur for this same reason. For normal operating conditions, a trued finish or smooth bored finish is sufficient for the fitting surface; however, a ground finish is necessary for applications where vibration and noise must be low. The accuracy and surface finish of shafts and housings for normal operating conditions are listed in **Table 7.5**.

Table 7.5 Accuracy and roughness of shaft and housing

Item	Class of bearings	Shaft	Housing bore
Tolerance for out-of-roundness	Normal, Class 6	$\frac{IT3}{2}$ to $\frac{IT4}{2}$	$\frac{IT4}{2}$ to $\frac{IT5}{2}$
	Class 5, Class 4	$\frac{IT3}{2}$ to $\frac{IT4}{2}$	$\frac{IT2}{2}$ to $\frac{IT3}{2}$
Tolerance for cylindricality	Normal, Class 6	$\frac{IT3}{2}$ to $\frac{IT4}{2}$	$\frac{IT4}{2}$ to $\frac{IT5}{2}$
	Class 5, Class 4	$\frac{IT2}{2}$ to $\frac{IT3}{2}$	$\frac{IT2}{2}$ to $\frac{IT3}{2}$
Tolerance for shoulder runout	Normal, Class 6 Class 5, Class 4	IT3 IT3	IT3 to IT4 IT3
Roughness of fitting surfaces Ra	—	0.8	1.6

**Remarks** This table is for general recommendation using the radius measuring method. The basic tolerance (IT) class should be selected in accordance with the bearing precision class. For the IT values, please refer to **Appendix Table 8** (Page 62).

## 7.2 Bearing internal clearances

The internal clearance of ball bearings greatly influences their performance, including fatigue life, vibration, noise, heat generation, etc. Consequently, it is necessary to select the proper clearance considering the bearing fit, load, speed and operating temperature. NSK provides clearances in six steps as shown in **Table 7.6**. To obtain accurate measurements, the clearance is generally measured by applying a specified measuring load on the bearing. As a result, the measured clearance is always

slightly larger than the theoretical internal clearance by the amount of elastic deformation caused by the measuring load. The theoretical internal clearance may thus be obtained by correcting the measured clearance by the amount of elastic deformation (refer to **Table 7.6** Remark #2). **Table 7.7** shows the criteria for selecting the radial clearance for extra small and miniature ball bearings.

Table 7.6 Radial internal clearances in extra small and miniature ball bearings

Units:  $\mu\text{m}$

Clearance symbol	MC1		MC2		MC3		MC4		MC5		MC6	
	min.	max.	min.	max.	min.	max.	min.	max.	min.	max.	min.	max.
Clearance	0	5	3	8	5	10	8	13	13	20	20	28

**Remarks** 1. The standard clearance is MC3.  
2. To obtain the measured value, add the correction amount in the table below.

Units:  $\mu\text{m}$

Clearance symbol	MC1	MC2	MC3	MC4	MC5	MC6
Clearance correction for measuring load	1	1	1	1	2	2

The measuring loads are as follows:  
For miniature ball bearings 2.5 N (0.25 kg)  
For extra small ball bearings 4.4 N (0.45 kgf)

Table 7.7 Selection of radial clearances

Typical application	Requirement	Clearance symbol	Remarks
Shafts for precision gears, servo-mechanisms, stepping motors, VCR capstan motors, other low-speed applications	<ul style="list-style-type: none"> <li>Small bearing clearance is required with no preload.</li> <li>Low torque is not important.</li> <li>High axial rigidity is not required.</li> </ul>	MC1 MC2	Avoid interference fits.
Synchros, gyro gimbal radial bearings, VCR drum spindles, computer disk spindles, polygonal mirror scanner motors, other low or medium-speed applications	<ul style="list-style-type: none"> <li>Low torque is required.</li> <li>Axial load and rigidity are normal.</li> </ul>	MC3 MC4	Avoid interference fits in most applications.
Gyro rotors, gyro gimbal thrust bearings, fan motors, vacuum cleaners, other high-speed and high-temperature applications	<ul style="list-style-type: none"> <li>Extremely low torque is required.</li> <li>High endurance and high axial rigidity are required.</li> </ul>	MC5 MC6	<ul style="list-style-type: none"> <li>Either axial clearance is made adjustable or a spring preload is used.</li> <li>Interference fit may be allowed.</li> </ul>

## 8. Lubrication

### 8.1 Purposes of lubrication

The main purpose of lubrication is to reduce friction and wear inside bearings that may cause premature failure. The effects of lubrication can be briefly explained as follows:

**(1) Reduction of friction and wear**

Direct metallic contact between the bearing rings, rolling elements and cage is prevented by a lubricant film.

**(2) Extension of fatigue life**

The rolling fatigue life of bearings depends greatly upon the viscosity and film thickness between the rolling contact surfaces. Sufficient film thickness prolongs the fatigue life while film thickness shortens it.

**(3) Dissipation of frictional heat and cooling**

Circulating lubrication may be used to carry away frictional heat or heat transferred from outside the bearing.

**(4) Others**

Adequate lubrication also helps to prevent foreign matter from entering bearings and guards against corrosion and rust.

### 8.2 Lubricating methods and lubricants

Lubricating methods are first divided into either grease or oil lubrication. Satisfactory bearing performance can be achieved by adopting the lubricating method which is most suitable for the particular application and operating conditions. In general, oil offers superior lubrication. However, grease lubrication allows a simpler structure around the bearings. A comparison of grease and oil lubrication is given in **Table 8.1**.

**(1) Grease lubrication**

Sealed (DD, VV) or shielded (ZZ, ZZS) bearings are generally factory-packed with the proper quantity of good quality grease and can be used as delivered. Too much grease can cause heat generation or grease leakage. Generally, NSK fills less than half of the free internal space inside bearings with grease. Because the brand of grease affects bearing performance, NSK usually recommends those shown in **Tables 8.2** and **8.3** on page 27. Among them, Multemp PS2 is often used as the standard grease for many applications. Besides those listed in **Tables 8.2** and **8.3**, many other brands are available. For assistance when selecting grease, consult NSK.

**(2) Oil lubrication**

Oil lubrication is used under conditions where satisfactory performance is difficult to achieve using grease, for example, when extremely low torque is required or for high-speed operation. Particularly in the case of gyro gimbal and synchros, which are largely affected by frictional torque, a low viscosity oil is used. Oil mist or oil/air lubrication provides low heating due to agitation and also superior cooling of the bearing. Aeroshell Fluid 12 (MIL-L-6085A) is the standard oil of NSK.

Table 8.2 Specifications of general-purpose greases

Grease name	Manufacturer	Thickener	Base oil	Dropping point (°C)	Consistency	Working temperature range (°C)	Usable speed limit (%)	Characteristics
MULTEMP PS No.2	Kyodo Yushi	Lithium soap	Poly- $\alpha$ -olefin oil + Diester oil	190	275	-50 to +110	100	For low temperatures, low torque
NS HI-LUBE	Kyodo Yushi	Lithium soap	Polyol ester oil + Diester oil	192	250	-40 to +130	100	Wide temperature range, low noise, low torque

Table 8.3 Specifications of greases developed by NSK

Grease symbol	Thickener	Base oil	Dropping point (°C)	Consistency	Working temperature range (°C)	Usable speed limit (%)	Characteristics	Main applications
VTG	Lithium soap	Poly- $\alpha$ -olefin oil + Diester oil	187	315	-50 to +110	100	Low noise, low torque	Video cassette recorder drum spindles
NSC	Lithium soap	Alkyldiphenyl ether oil + Polyol ester oil	192	235	-30 to +140	70	Wide temperature range	Office automation machines Fan motors
EA3	Urea	Poly- $\alpha$ -olefin oil	$\geq 260$	230	-40 to +150	100	For high speeds and high temperatures	Vacuum cleaners Cooling fan motors for cars
ENS	Urea	Polyol ester oil	$\geq 260$	264	-40 to +160	100	For high temperatures	General purpose

Table 8.1 Comparison of grease and oil lubrication

Item	Grease lubrication	Oil lubrication
Housing structure and sealing method	Simple	May be complex. Careful maintenance required.
Speed	Limiting speed is 65 % to 80 % of that with oil lubrication.	High limiting speed
Cooling effect	Poor	Heat transfer is possible using forced oil circulation.
Fluidity	Poor	Good
Full lubricant replacement	Sometimes difficult	Easy
Removal of foreign matter	Removal of particles from grease is impossible.	Easy
External contamination due to leakage	Surroundings seldom contaminated by leakage.	Often leaks without proper countermeasures. Not suitable if external contamination must be avoided.



## 9. Bearing materials

The bearing rings and rolling elements of rolling bearings are repeatedly subjected to high pressure with a small amount of sliding. The materials used for the rings and rolling elements must therefore have the following characteristics:

- High rolling contact fatigue strength
- High hardness
- High wear resistance
- High dimensional stability
- High mechanical strength

Other characteristics, such as ease of production, shock and heat resistance, and corrosion resistance, are required depending on individual applications.

The material used for the rings and balls in miniature ball bearings is either bearing steel or martensitic stainless steel. The chemical composition of each is shown in **Table 9.1**.

Bearing steel provides a longer fatigue life because of its high hardness, and it is also superior with respect to running noise and torque. Stainless steel has good corrosion

resistance and its hardness does not decrease at high temperature. Therefore, it is used in applications where corrosive elements exist or where operating temperatures are unusually high.

NSK uses vacuum degassed bearing steel designated by Japanese Industrial Standard (JIS) as SUJ2 (equivalent to ASTM A 295 52100). Its stainless steel is JIS SUS440C (equivalent to SAE J 405 51440C) produced using the Electro Slag Remelting Method (ESR).

NSK selects bearing steels containing a minimum of oxygen, hydrogen, nitrogen, and hydrogen-compound impurities.

The rolling fatigue life of bearings has been remarkably improved using these materials combined with the appropriate heat treatment.

Regarding stainless steel bearings with reduced noise, please consult NSK.

Table 9.1 Chemical composition of high-carbon chromium bearing steel and stainless steel

Standard	Symbol	Chemical composition (%)						
		C	Si	Mn	P	S	Cr	Mo
JIS G 4805	SUJ2	0.95 to 1.10	0.15 to 0.35	Less than 0.50	Less than 0.025	Less than 0.025	1.30 to 1.60	—
ASTM A 295	52100	0.93 to 1.05	0.15 to 0.35	0.25 to 0.45	Less than 0.025	Less than 0.015	1.30 to 1.60	Less than 0.10
JIS G 4303	SUS 440C	0.95 to 1.20	Less than 1.00	Less than 1.00	Less than 0.040	Less than 0.030	16.00 to 18.00	Less than 0.75
SAE J 405	51440C	0.95 to 1.20	Less than 1.00	Less than 1.00	Less than 0.040	Less than 0.030	16.00 to 18.00	Less than 0.75

# Bearing Tables





**Bearing Tables**  
**CONTENTS**

	Page
<b>Deep groove ball bearings</b>	
Single-row deep groove ball bearings .....	32 – 37
Metric series Bore diameter 1 – 9 mm .....	32 – 35
Inch series Bore diameter 1.016 – 9.525 mm .....	36 – 37
Deep groove ball bearings with flanged outer ring .....	38 – 43
Metric series Bore diameter 1 – 9 mm .....	38 – 41
Inch series Bore diameter 1.191 – 9.525 mm .....	42 – 43
Deep groove ball bearings with extended inner ring .....	44 – 45
Inch series Bore diameter 1.191 – 7.938 mm	
Deep groove ball bearings with extended inner ring, flanged .....	46 – 47
Inch series Bore diameter 1.191 – 7.938 mm	
Ball bearings for synchros .....	48 – 49
Inch series Bore diameter 1.984 – 6.350 mm	
Extra-thin-section deep groove ball bearings .....	50 – 51
Metric series Bore diameter 10 – 15 mm	
<b>Angular contact ball bearings</b>	
Metric series Bore diameter 4 – 9 mm .....	50 – 51



## Metric series

### 600, MR

#### Bore diameter

1 – 4 mm

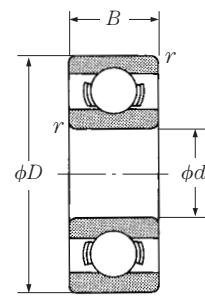

Open type

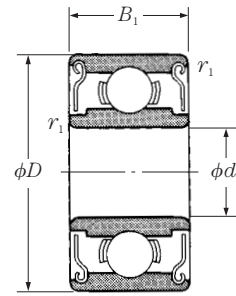

Shielded type  
ZZ · ZZ1

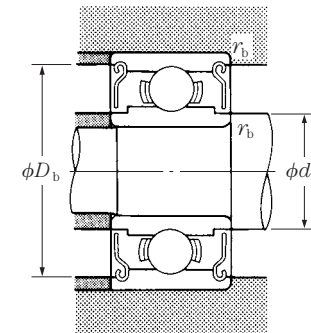
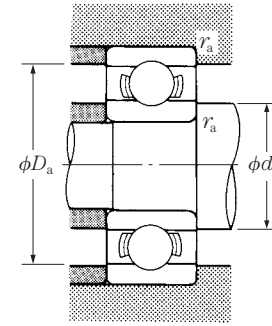

d	Boundary dimensions (mm)					Basic load ratings (N)				Limiting speeds (min <sup>-1</sup> )		Bearing numbers			Abutment and fillet dimensions (mm)						Mass (g)		Basic bearing numbers	Actual size <sup>(2)</sup>			
	D	B	B <sub>1</sub>	r <sup>(1)</sup> min.	r <sub>1</sub> <sup>(1)</sup> min.	C <sub>r</sub>	C <sub>or</sub>	C <sub>r</sub>	C <sub>or</sub>	Grease Open Z · ZZ	Oil Open Z	Open	Shielded	Seals	d <sub>a</sub> min.	d <sub>b</sub> max.	D <sub>a</sub> max.	D <sub>b</sub> min.	r <sub>a</sub> max.	r <sub>b</sub> max.	Open approx.	Shielded approx.					
<b>1</b>	3	1	—	0.05	—	80	23	8	2.5	130 000	150 000	<b>681</b>	—	—	1.4	—	2.6	—	0.05	—	0.03	—	<b>681</b> <b>MR 31</b> <b>691</b>				
	3	1.5	—	0.05	—	80	23	8	2.5	130 000	150 000	<b>MR 31</b>	—	—	1.4	—	2.6	—	0.05	—	0.04	—					
	4	1.6	—	0.1	—	138	35	14	3.5	100 000	120 000	<b>691</b>	—	—	1.8	—	3.2	—	0.1	—	0.09	—					
<b>1.2</b>	4	1.8	2.5	0.1	0.1	138	35	14	3.5	110 000	130 000	<b>MR 41 X</b>	<b>MR 41 XZZ</b>	—	2.0	1.9	3.2	3.5	0.1	0.1	0.10	0.14	<b>MR 41 X</b>				
<b>1.5</b>	4	1.2	2	0.05	0.05	112	33	11	3.5	100 000	120 000	<b>681 X</b>	<b>681 XZZ</b>	—	1.9	2.1	3.6	3.6	0.05	0.05	0.07	0.11	<b>681 X</b> <b>691 X</b> <b>601 X</b>				
	5	2	2.6	0.15	0.15	237	69	24	7	85 000	100 000	<b>691 X</b>	<b>691 XZZ</b>	—	2.7	2.5	3.8	4.3	0.15	0.15	0.17	0.20					
	6	2.5	3	0.15	0.15	330	98	34	10	75 000	90 000	<b>601 X</b>	<b>601 XZZ</b>	—	2.7	3.0	4.8	5.4	0.15	0.15	0.33	0.38					
<b>2</b>	5	1.5	2.3	0.08	0.08	169	50	17	5	85 000	100 000	<b>682</b>	<b>682 ZZ</b>	—	2.6	2.7	4.4	4.2	0.08	0.08	0.12	0.17	<b>682</b> <b>MR 52 B</b> <b>692</b>				
	5	2	2.5	0.1	0.1	187	58	19	6	85 000	100 000	<b>MR 52 B</b>	<b>MR 52 BZZ</b>	—	2.8	2.7	4.2	4.4	0.1	0.1	0.16	0.23					
	6	2.3	3	0.15	0.15	330	98	34	10	75 000	90 000	<b>692</b>	<b>692 ZZ</b>	—	3.2	3.0	4.8	5.4	0.15	0.15	0.28	0.38					
<b>2.5</b>	6	2.5	2.5	0.15	0.15	330	98	34	10	75 000	90 000	<b>MR 62</b>	<b>MR 62 ZZ</b>	—	3.2	3.0	4.8	5.4	0.15	0.15	0.30	0.29	<b>MR 62</b> <b>MR 72</b> <b>602</b> <b>682 X</b> <b>692 X</b>				
	7	2.5	3	0.15	0.15	385	127	39	13	63 000	75 000	<b>MR 72</b>	<b>MR 72 ZZ</b>	—	3.2	3.8	5.8	6.2	0.15	0.15	0.45	0.49					
	7	2.8	3.5	0.15	0.15	385	127	39	13	63 000	75 000	<b>602</b>	<b>602 ZZ</b>	—	3.2	3.8	5.8	6.2	0.15	0.15	0.51	0.58					
	6	1.8	2.6	0.08	0.08	208	74	21	7.5	71 000	80 000	<b>682 X</b>	<b>682 XZZ</b>	—	3.1	3.7	5.4	5.4	0.08	0.08	0.23	0.29					
	7	2.5	3.5	0.15	0.15	385	127	39	13	63 000	75 000	<b>692 X</b>	<b>692 XZZ</b>	—	3.7	3.8	5.8	6.2	0.15	0.15	0.41	0.55					
<b>3</b>	8	2.5	—	0.2	—	560	179	57	18	60 000	67 000	<b>MR 82 X</b>	—	—	4.1	—	6.4	—	0.2	—	0.56	—	<b>MR 82 X</b> <b>602 X</b>				
	8	2.8	4	0.15	0.15	550	175	56	18	60 000	71 000	<b>602 X</b>	<b>602 XZZ</b>	—	3.7	4.1	6.8	7.0	0.15	0.15	0.63	0.83					
	6	2	2.5	0.1	0.1	208	74	21	7.5	71 000	80 000	<b>MR 63</b>	<b>MR 63 ZZ</b>	—	3.8	3.7	5.2	5.4	0.1	0.1	0.20	0.27					
<b>3</b>	7	2	3	0.1	0.1	390	130	40	13	63 000	75 000	<b>683 A</b>	<b>683 AZZ</b>	—	3.8	4.0	6.2	6.4	0.1	0.1	0.32	0.45	<b>MR 63</b> <b>683 A</b> <b>MR 83</b> <b>693</b> <b>MR 93</b> <b>603</b> <b>623</b> <b>633</b>				
	8	2.5	—	0.15	—	560	179	57	18	60 000	67 000	<b>MR 83</b>	—	—	4.2	—	6.8	—	0.15	—	0.54	—					
	8	3	4	0.15	0.15	560	179	57	18	60 000	67 000	<b>693</b>	<b>693 ZZ</b>	—	4.2	4.3	6.8	7.3	0.15	0.15	0.61	0.83					
	9	2.5	4	0.2	0.15	570	187	58	19	56 000	67 000	<b>MR 93</b>	<b>MR 93 ZZ</b>	—	4.6	4.3	7.4	7.9	0.2	0.15	0.73	1.18					
	9	3	5	0.15	0.15	570	187	58	19	56 000	67 000	<b>603</b>	<b>603 ZZ</b>	—	4.2	4.3	7.8	7.9	0.15	0.15	0.87	—					
	10	4	4	0.15	0.15	630	218	64	22	50 000	60 000	<b>623</b>	<b>623 ZZ</b>	—	4.2	4.3	8.8	8.0	0.15	0.15	1.65	1.66					
	13	5	5	0.2	0.2	1 300	485	133	49	40 000	48 000	<b>633</b>	<b>633 ZZ</b>	—	4.6	6.0	11.4	11.3	0.2	0.2	3.38	3.33					
	<b>4</b>	7	2	—	0.1	—	310	115	32	12	60 000	67 000	<b>MR 74</b>	—	—	4.8	—	6.2	—	0.1	—	0.22			—	<b>MR 74</b> <b>MR 84</b> <b>684 A</b> <b>MR 104 B</b> <b>694</b> <b>604</b> <b>624</b> <b>634</b>	
		7	—	2.5	—	0.1	255	107	26	11	60 000	71 000	—	<b>MR 74 ZZ</b>	—	—	4.8	—	6.3	—	0.1	—			—		
8		2	3	0.15	0.1	395	139	40	14	56 000	67 000	<b>MR 84</b>	<b>MR 84 ZZ</b>	—	5.2	5.0	6.8	7.4	0.15	0.1	0.36	0.56					
9		2.5	4	(0.15)	(0.15)	640	225	65	23	53 000	63 000	<b>684 A</b>	<b>684 AZZ</b>	—	4.8	5.2	8.2	8.1	0.1	0.1	0.63	1.01					
10		3	4	0.2	0.15	710	270	73	28	50 000	60 000	<b>MR 104 B</b>	<b>MR 104 BZZ</b>	—	5.6	5.9	8.4	8.8	0.2	0.15	1.04	1.42					
11		4	4	0.15	0.15	960	345	98	35	48 000	56 000	<b>694</b>	<b>694 ZZ</b>	—	5.2	5.6	9.8	9.9	0.15	0.15	1.7	1.75					
12	4	4	0.2	0.2	960	345	98	35	48 000	56 000	<b>604</b>	<b>604 ZZ</b>	—	5.6	5.6	10.4	9.9	0.2	0.2	2.25	2.29						
13	5	5	0.2	0.2	1 300	485	133	49	40 000	48 000	<b>624</b>	<b>624 ZZ</b>	—	5.6	6.0	11.4	11.3	0.2	0.2	3.03	3.04						
16	5	5	0.3	0.3	1 730	670	177	68	36 000	43 000	<b>634</b>	<b>634 ZZ1</b>	—	6.0	7.5	14.0	13.8	0.3	0.3	5.24	5.21						

Notes <sup>(1)</sup> The values in parentheses are not based on ISO 15.

<sup>(2)</sup> Actual dimensions of bore and outside diameter only.

Remarks 1. When using bearings with a rotating outer ring, please contact NSK if they are shielded.  
2. Bearings with double shields (ZZ, ZZ1) are also available with single shields (Z, Z1).

**Metric series**  
**600, MR**  
**Bore diameter**  
**5 – 9 mm**

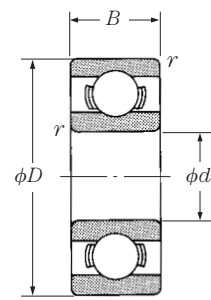

Open type

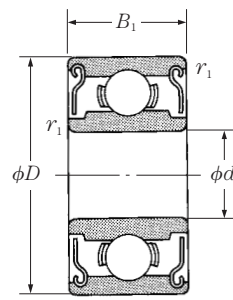

Shielded type  
ZZ · ZZ1

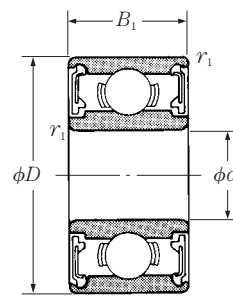

Non-contact  
sealed type  
VV

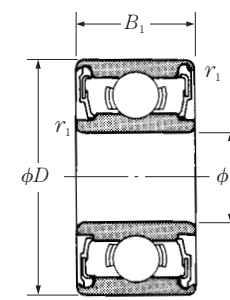

Contact sealed type  
DD

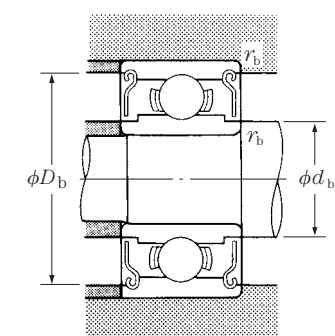
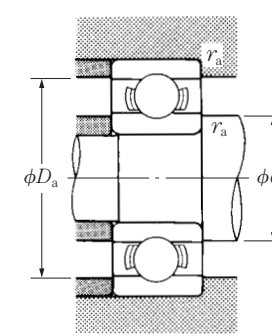

d	Boundary dimensions (mm)					Basic load ratings (N) {kgf}				Limiting speeds (min <sup>-1</sup> ) Grease			Bearing numbers			Abutment and fillet dimensions (mm)						Mass (g)		Basic bearing numbers	Actual size <sup>(2)</sup>		
	D	B	B <sub>1</sub>	r <sup>(1)</sup> min.	r <sub>1</sub> <sup>(1)</sup> min.	C <sub>r</sub>	C <sub>or</sub>	C <sub>r</sub>	C <sub>or</sub>	Open Z·ZZ V·W	D·DD	Oil Open Z	Open	Shielded	Seals	d <sub>a</sub> min.	d <sub>b</sub> max.	D <sub>a</sub> max.	D <sub>b</sub> min.	r <sub>a</sub> max.	r <sub>b</sub> max.	Open approx.	Shielded approx.				
5	8	2	—	0.1	—	310	120	31	12	53 000	—	63 000	<b>MR 85</b>	—	—	—	5.8	—	7.2	—	0.1	—	0.26	—	<b>MR 85</b> <b>MR 85</b> <b>MR 95</b> <b>MR 105</b> <b>MR 115</b>  <b>685</b> <b>695</b> <b>605</b>  <b>625</b> <b>635</b>  <b>MR 106</b> <b>MR 126</b> <b>686 A</b>  <b>696</b> <b>606</b> <b>626</b> <b>636</b>  <b>MR 117</b> <b>MR 137</b> <b>687</b>  <b>697</b> <b>607</b> <b>627</b> <b>637</b>  <b>MR 128</b> <b>MR 148</b> <b>688 A</b>  <b>698</b> <b>608</b> <b>628</b> <b>638</b>  <b>689</b> <b>699</b> <b>609</b>  <b>629</b> <b>639</b>		
	8	—	2.5	—	0.1	278	131	28	13	53 000	—	63 000	—	<b>MR 85 ZZ</b>	—	—	—	5.8	—	7.4	—	0.1	—	0.34			—
	9	2.5	3	0.15	0.15	430	168	44	17	50 000	—	60 000	<b>MR 95</b>	<b>MR 95 ZZ1</b>	—	—	6.2	6.0	7.8	8.2	0.15	0.15	0.50	0.58			
	10	3	4	0.15	0.15	430	168	44	17	50 000	—	60 000	<b>MR 105</b>	<b>MR 105 ZZ</b>	—	—	6.2	6.0	8.8	8.4	0.15	0.15	0.95	1.29			
	11	—	4	—	0.15	715	276	73	28	48 000	—	56 000	—	<b>MR 115 ZZ</b>	<b>VV</b>	—	—	6.3	—	9.8	—	0.15	—	—			1.5
	11	3	5	0.15	0.15	715	281	73	29	45 000	—	53 000	<b>685</b>	<b>685 ZZ</b>	—	—	6.2	6.2	9.8	9.9	0.15	0.15	1.2	1.96			
	13	4	4	0.2	0.2	1 080	430	110	44	43 000	40 000	50 000	<b>695</b>	<b>695 ZZ1</b>	<b>VV</b>	<b>DD</b>	6.6	6.6	11.4	11.2	0.2	0.2	2.45	2.5			
	14	5	5	0.2	0.2	1 330	505	135	52	40 000	38 000	50 000	<b>605</b>	<b>605 ZZ</b>	—	<b>DD</b>	6.6	6.9	12.4	12.2	0.2	0.2	3.54	3.48			
	16	5	5	0.3	0.3	1 730	670	177	68	36 000	32 000	43 000	<b>625</b>	<b>625 ZZ1</b>	<b>VV</b>	<b>DD</b>	7.0	7.5	14.0	13.8	0.3	0.3	4.95	4.86			
	19	6	6	0.3	0.3	2 340	885	238	90	32 000	30 000	40 000	<b>635</b>	<b>635 ZZ1</b>	<b>VV</b>	<b>DD</b>	7.0	8.5	17.0	16.5	0.3	0.3	8.56	8.34			
6	10	2.5	3	0.15	0.1	495	218	51	22	45 000	—	53 000	<b>MR 106</b>	<b>MR 106 ZZ1</b>	—	—	7.2	7.0	8.8	9.3	0.15	0.1	0.56	0.68			
	12	3	4	0.2	0.15	715	292	73	30	43 000	40 000	50 000	<b>MR 126</b>	<b>MR 126 ZZ</b>	—	<b>DD</b>	7.6	7.2	10.4	10.9	0.2	0.15	1.27	1.74			
	13	3.5	5	0.15	0.15	1 080	440	110	45	40 000	38 000	50 000	<b>686 A</b>	<b>686 A ZZ</b>	<b>VV</b>	<b>DD</b>	7.2	7.4	11.8	11.7	0.15	0.15	1.91	2.69			
	15	5	5	0.2	0.2	1 730	670	177	68	40 000	36 000	45 000	<b>696</b>	<b>696 ZZ1</b>	<b>VV</b>	<b>DD</b>	7.6	7.9	13.4	13.3	0.2	0.2	3.88	3.72			
	17	6	6	0.3	0.3	2 260	835	231	85	38 000	34 000	45 000	<b>606</b>	<b>606 ZZ</b>	<b>VV</b>	<b>DD</b>	8.0	8.2	15.0	14.8	0.3	0.3	5.97	6.08			
	19	6	6	0.3	0.3	2 340	885	238	90	32 000	30 000	40 000	<b>626</b>	<b>626 ZZ1</b>	<b>VV</b>	<b>DD</b>	8.0	8.5	17.0	16.5	0.3	0.3	8.15	7.94			
	22	7	7	0.3	0.3	3 300	1 370	335	140	30 000	28 000	36 000	<b>636</b>	<b>636 ZZ</b>	<b>VV</b>	<b>DD</b>	8.0	10.5	20.0	19.0	0.3	0.3	14	14			
7	11	2.5	3	0.15	0.1	455	201	47	21	43 000	—	50 000	<b>MR 117</b>	<b>MR 117 ZZ</b>	—	—	8.2	8.0	9.8	10.5	0.15	0.1	0.62	0.72			
	13	3	4	0.2	0.15	540	276	55	28	40 000	—	48 000	<b>MR 137</b>	<b>MR 137 ZZ</b>	—	—	8.6	9.0	11.4	11.6	0.2	0.15	1.58	2.02			
	14	3.5	5	0.15	0.15	1 170	510	120	52	40 000	34 000	45 000	<b>687</b>	<b>687 ZZ1</b>	<b>VV</b>	<b>DD</b>	8.2	8.5	12.8	12.7	0.15	0.15	2.13	2.97			
	17	5	5	0.3	0.3	1 610	710	164	73	36 000	28 000	43 000	<b>697</b>	<b>697 ZZ1</b>	<b>VV</b>	<b>DD</b>	9.0	10.2	15.0	14.8	0.3	0.3	5.26	5.12			
	19	6	6	0.3	0.3	2 340	885	238	90	36 000	32 000	43 000	<b>607</b>	<b>607 ZZ1</b>	<b>VV</b>	<b>DD</b>	9.0	9.1	17.0	16.5	0.3	0.3	7.67	7.51			
	22	7	7	0.3	0.3	3 300	1 370	335	140	30 000	28 000	36 000	<b>627</b>	<b>627 ZZ</b>	<b>VV</b>	<b>DD</b>	9.0	10.5	20.0	19.0	0.3	0.3	12.7	12.9			
8	12	2.5	3.5	0.15	0.1	545	274	56	28	40 000	—	48 000	<b>MR 128</b>	<b>MR 128 ZZ1</b>	—	—	9.2	9.0	10.8	11.3	0.15	0.1	0.71	0.97			
	14	3.5	4	0.2	0.15	820	385	83	39	38 000	32 000	45 000	<b>MR 148</b>	<b>MR 148 ZZ</b>	<b>VV</b>	<b>DD</b>	9.6	9.2	12.4	12.8	0.2	0.15	1.86	2.16			
	16	4	5	0.2	0.2	1 610	710	164	73	36 000	28 000	43 000	<b>688 A</b>	<b>688 A ZZ1</b>	<b>VV</b>	<b>DD</b>	9.6	10.2	14.4	14.2	0.2	0.2	3.12	4.02			
	19	6	6	0.3	0.3	2 240	910	228	93	36 000	28 000	43 000	<b>698</b>	<b>698 ZZ</b>	<b>VV</b>	<b>DD</b>	10.0	10.0	17.0	16.5	0.3	0.3	7.23	7.18			
	22	7	7	0.3	0.3	3 300	1 370	335	140	34 000	28 000	40 000	<b>608</b>	<b>608 ZZ</b>	<b>VV</b>	<b>DD</b>	10.0	10.5	20.0	19.0	0.3	0.3	12.1	12.2			
	24	8	8	0.3	0.3	3 350	1 430	340	146	28 000	24 000	34 000	<b>628</b>	<b>628 ZZ</b>	<b>VV</b>	<b>DD</b>	10.0	12.0	22.0	20.5	0.3	0.3	17.2	17.4			
	28	9	9	0.3	0.3	4 550	1 970	465	201	28 000	22 000	34 000	<b>638</b>	<b>638 ZZ1</b>	<b>VV</b>	<b>DD</b>	10.0	12.8	26.0	22.8	0.3	0.3	28.3	28.6			
	9	17	4	5	0.2	0.2	1 330	665	136	68	36 000	24 000	43 000	<b>689</b>	<b>689 ZZ1</b>	<b>VV</b>	<b>DD</b>	10.6	11.5	15.4	15.2	0.2	0.2	3.53	4.43		
20		6	6	0.3	0.3	1 720	840	175	86	34 000	24 000	40 000	<b>699</b>	<b>699 ZZ1</b>	<b>VV</b>	<b>DD</b>	11.0	12.0	18.0	17.2	0.3	0.3	8.45	8.33			
24		7	7	0.3	0.3	3 350	1 430	340	146	32 000	24 000	38 000	<b>609</b>	<b>609 ZZ</b>	<b>VV</b>	<b>DD</b>	11.0	12.0	22.8	20.5	0.3	0.3	14.5	14.7			
26		8	8	(0.6)	(0.6)	4 550	1 970	465	201	28 000	22 000	34 000	<b>629</b>	<b>629 ZZ</b>	<b>VV</b>	<b>DD</b>	11.0	12.8	24.0	22.8	0.3	0.3	19.5	19.3			
30		10	10	0.6	0.6	5 100	2 390	520	244	24 000	—	30 000	<b>639</b>	<b>639 ZZ</b>	<b>VV</b>	—	13.0	16.1	26.0	25.6	0.6	0.6	36.5	36			

**Notes** (1) The values in parentheses are not based on ISO 15.

(2) Actual dimensions of bore and outside diameter only.

**Remarks** 1. When using bearings with a rotating outer ring, please contact NSK if they are sealed or shielded.  
 2. Bearings with double shields (ZZ, ZZ1) are also available with single shields (Z, Z1).  
 3. Bearings with snap rings are also available, please contact NSK.



## Inch series

### R

#### Bore diameter

1.016 – 9.525 mm

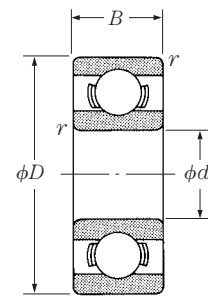

Open type

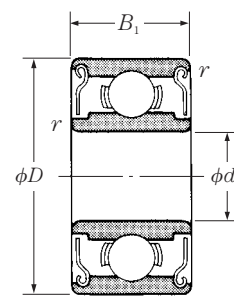

Shielded type  
ZZ · ZS

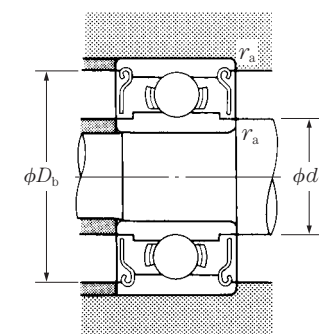
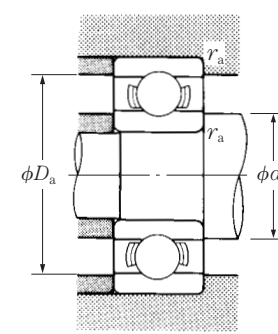

d	Boundary dimensions (mm/inch)					Basic load ratings (N/kgf)				Limiting speeds (min <sup>-1</sup> )		Bearing numbers		Abutment and fillet dimensions (mm)					Mass (g)		Basic bearing numbers	Actual size <sup>(1)</sup>			
	D	B	B <sub>1</sub>	r min.	C <sub>r</sub>	C <sub>or</sub>	C <sub>r</sub>	C <sub>or</sub>	Grease Open Z-ZZ	Oil Open Z	Open	Shielded	d <sub>a</sub> min.	d <sub>b</sub> max.	D <sub>a</sub> max.	D <sub>b</sub> min.	r <sub>a</sub> max.	Open approx.	Shielded approx.						
1.016	0.0400	3.175	0.1250	1.191	0.0469	—	—	0.1	80	23	8	2.5	130 000	150 000	<b>R 09</b>	—	1.9	—	2.3	—	0.1	0.04	—	<b>R 09</b>	
1.191	0.0469	3.967	0.1562	1.588	0.0625	2.380	0.0937	0.1	138	35	14	3.5	110 000	130 000	<b>R 0</b>	<b>R 0 ZZ</b>	2.0	1.9	3.1	3.5	0.1	0.09	0.11	<b>R 0</b>	
1.397	0.0550	4.762	0.1875	1.984	0.0781	2.779	0.1094	0.1	231	66	24	6.5	90 000	110 000	<b>R 1</b>	<b>R 1 ZZ</b>	2.2	2.3	3.9	4.1	0.1	0.15	0.19	<b>R 1</b>	
1.984	0.0781	6.350	0.2500	2.380	0.0937	3.571	0.1406	0.1	310	108	32	11	67 000	80 000	<b>R 1-4</b>	<b>R 1-4 ZZ</b>	2.8	3.9	5.5	5.9	0.1	0.35	0.50	<b>R 1-4</b>	
2.380	0.0937	4.762	0.1875	1.588	0.0625	—	—	0.1	188	60	19	6	80 000	95 000	<b>R 133</b>	—	3.2	—	3.9	—	0.1	0.10	—	<b>R 133</b>	
		4.762	0.1875	—	—	2.380	0.0937	0.1	143	52	15	5.5	80 000	95 000	—	<b>R 133 ZZS</b>	—	3.0	—	4.2	0.1	—	0.13	<b>R 133</b>	
		7.938	0.3125	2.779	0.1094	3.571	0.1406	0.15	550	175	56	18	60 000	71 000	<b>R 1-5</b>	<b>R 1-5 ZZ</b>	3.6	4.1	6.7	7.0	0.15	0.60	0.72	<b>R 1-5</b>	
3.175	0.1250	6.350	0.2500	2.380	0.0937	2.779	0.1094	0.1	283	95	29	9.5	67 000	80 000	<b>R 144</b>	<b>R 144 ZZ</b>	4.0	3.9	5.5	5.9	0.1	0.25	0.27	<b>R 144</b>	
		7.938	0.3125	2.779	0.1094	3.571	0.1406	0.1	560	179	57	18	60 000	67 000	<b>R 2-5</b>	<b>R 2-5 ZZ</b>	4.0	4.3	7.1	7.3	0.1	0.55	0.72	<b>R 2-5</b>	
		9.525	0.3750	2.779	0.1094	3.571	0.1406	0.15	640	225	65	23	53 000	63 000	<b>R 2-6</b>	<b>R 2-6 ZZS</b>	4.4	4.6	8.3	8.2	0.15	0.96	1.13	<b>R 2-6</b>	
3.175	0.1250	9.525	0.3750	3.967	0.1562	3.967	0.1562	0.3	630	218	64	22	56 000	67 000	<b>R 2</b>	<b>R 2 ZZ</b>	5.2	4.8	7.5	8.0	0.3	1.36	1.39	<b>R 2</b>	
		12.700	0.5000	4.366	0.1719	4.366	0.1719	0.3	640	225	65	23	53 000	63 000	<b>R 2 A</b>	<b>R 2 A ZZ</b>	5.2	4.6	10.7	8.2	0.3	3.3	3.23	<b>R 2 A</b>	
3.967	0.1562	7.938	0.3125	2.779	0.1094	3.175	0.1250	0.1	360	149	37	15	53 000	63 000	<b>R 155</b>	<b>R 155 ZZS</b>	4.8	5.5	7.1	7.3	0.1	0.51	0.56	<b>R 155</b>	
4.762	0.1875	7.938	0.3125	2.779	0.1094	3.175	0.1250	0.1	360	149	37	15	53 000	63 000	<b>R 156</b>	<b>R 156 ZZS</b>	5.6	5.5	7.1	7.3	0.1	0.39	0.42	<b>R 156</b>	
		9.525	0.3750	3.175	0.1250	3.175	0.1250	0.1	710	270	73	28	50 000	60 000	<b>R 166</b>	<b>R 166 ZZ</b>	5.6	5.9	8.7	8.8	0.1	0.81	0.85	<b>R 166</b>	
		12.700	0.5000	3.967	0.1562	4.978	0.1960	0.3	1 300	485	133	49	43 000	53 000	<b>R 3</b>	<b>R 3 ZZ</b>	6.8	6.5	10.7	11.2	0.3	2.21	2.79	<b>R 3</b>	
6.350	0.2500	9.525	0.3750	3.175	0.1250	3.175	0.1250	0.1	420	204	43	21	48 000	56 000	<b>R 168 B</b>	<b>R 168 B ZZ</b>	7.2	7.0	8.7	8.9	0.1	0.58	0.62	<b>R 168 B</b>	
		12.700	0.5000	3.175	0.1250	4.762	0.1875	0.15	1 080	440	110	45	40 000	50 000	<b>R 188</b>	<b>R 188 ZZ</b>	7.6	7.4	11.5	11.6	0.15	1.53	2.21	<b>R 188</b>	
6.350	0.2500	15.875	0.6250	4.978	0.1960	4.978	0.1960	0.3	1 610	660	164	68	38 000	45 000	<b>R 4 B</b>	<b>R 4 B ZZ</b>	8.4	8.4	13.8	13.8	0.3	4.50	4.43	<b>R 4 B</b>	
		19.050	0.7500	5.558	0.2188	7.142	0.2812	0.4	2 620	1 060	267	108	36 000	43 000	<b>R 4 AA</b>	<b>R 4 AA ZZ</b>	9.4	9.0	16.0	16.6	0.4	7.48	9.17	<b>R 4 AA</b>	
7.938	0.3125	12.700	0.5000	3.967	0.1562	3.967	0.1562	0.15	540	276	55	28	40 000	48 000	<b>R 1810</b>	<b>R 1810 ZZ</b>	9.2	9.0	11.5	11.6	0.15	1.56	1.48	<b>R 1810</b>	
9.525	0.3750	22.225	0.8750	5.558	0.2188	7.142	0.2812	0.4	3 350	1 410	340	144	32 000	38 000	<b>R 6</b>	<b>R 6 ZZ</b>	12.6	11.9	19.2	20.0	0.4	9.02	11	<b>R 6</b>	

Note <sup>(1)</sup> Actual dimensions of bore and outside diameter only.

Remarks 1. When using bearings with a rotating outer ring, please contact NSK if they are shielded.

2. Bearings with double shields (ZZ, ZZS) are also available with single shields (Z, ZS).

# Deep groove ball bearings with flanged outer ring

**Metric series**  
**F600, MF**  
**Bore diameter**  
**1 – 4 mm**

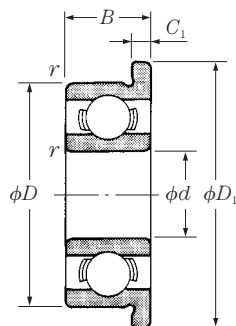

Open type

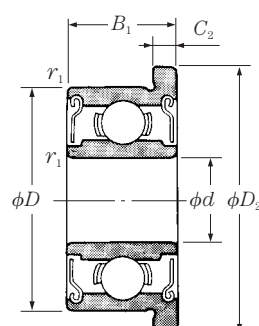

Shielded type  
 ZZ · ZZ1

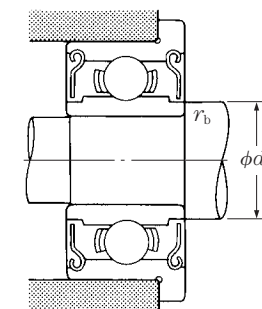
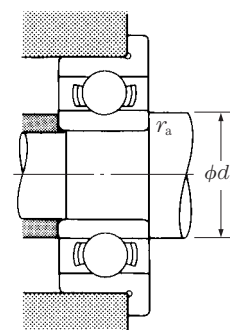

d	Boundary dimensions (mm)										Basic load ratings (N) {kgf}				Limiting speeds (min <sup>-1</sup> )		Bearing numbers			Abutment and fillet dimensions (mm)				Mass (g)		Basic bearing numbers	Actual size <sup>(2)</sup>		
	D	D <sub>1</sub>	D <sub>2</sub>	B	B <sub>1</sub>	C <sub>1</sub>	C <sub>2</sub>	r <sup>(1)</sup> min.	r <sub>1</sub> <sup>(1)</sup> min.	C <sub>r</sub>	C <sub>or</sub>	C <sub>r</sub>	C <sub>or</sub>	Grease Open Z·ZZ	Oil Open Z	Open	Shielded	Sealed	d <sub>a</sub> min.	d <sub>b</sub> max.	r <sub>a</sub> max.	r <sub>b</sub> max.	Open approx.	Shielded approx.					
1	3	3.8	—	1	—	0.3	—	0.05	—	80	23	8	2.5	130 000	150 000	<b>F 681</b>	—	—	—	1.4	—	0.05	—	0.04	—	<b>F 681</b>			
	4	5	—	1.6	—	0.5	—	0.1	—	138	35	14	3.5	100 000	120 000	<b>F 691</b>	—	—	—	1.8	—	0.1	—	0.14	—	<b>F 691</b>			
1.2	4	4.8	—	1.8	—	0.4	—	0.1	—	138	35	14	3.5	110 000	130 000	<b>MF 41 X</b>	—	—	—	2.0	—	0.1	—	0.12	—	<b>MF 41 X</b>			
1.5	4	5	5	1.2	2	0.4	0.6	0.05	0.05	112	33	11	3.5	100 000	120 000	<b>F 681 X</b>	<b>F 681 XZZ</b>	—	—	1.9	2.1	0.05	0.05	0.09	0.14	<b>F 681 X</b>			
	5	6.5	6.5	2	2.6	0.6	0.8	0.15	0.15	237	69	24	7	85 000	100 000	<b>F 691 X</b>	<b>F 691 XZZ</b>	—	—	2.7	2.5	0.15	0.15	0.21	0.28	<b>F 691 X</b>			
	6	7.5	7.5	2.5	3	0.6	0.8	0.15	0.15	330	98	34	10	75 000	90 000	<b>F 601 X</b>	<b>F 601 XZZ</b>	—	—	2.7	3.0	0.15	0.15	0.42	0.52	<b>F 601 X</b>			
2	5	6.1	6.1	1.5	2.3	0.5	0.6	0.08	0.08	169	50	17	5	85 000	100 000	<b>F 682</b>	<b>F 682 ZZ</b>	—	—	2.6	2.7	0.08	0.08	0.16	0.22	<b>F 682</b>			
	5	6.2	6.2	2	2.5	0.6	0.6	0.1	0.1	187	58	19	6	85 000	100 000	<b>MF 52 B</b>	<b>MF 52 B ZZ</b>	—	—	2.8	2.7	0.1	0.1	0.21	0.27	<b>MF 52 B</b>			
	6	7.5	7.5	2.3	3	0.6	0.8	0.15	0.15	330	98	34	10	75 000	90 000	<b>F 692</b>	<b>F 692 ZZ</b>	—	—	3.2	3.0	0.15	0.15	0.35	0.48	<b>F 692</b>			
2.5	6	7.2	—	2.5	—	0.6	—	0.15	—	330	98	34	10	75 000	90 000	<b>MF 62</b>	—	—	—	—	0.15	—	0.36	—	<b>MF 62</b>				
	7	8.2	8.2	2.5	3	0.6	0.6	0.15	0.15	385	127	39	13	63 000	75 000	<b>MF 72</b>	<b>MF 72 ZZ</b>	—	—	3.2	3.8	0.15	0.15	0.52	0.56		<b>MF 72</b>		
	7	8.5	8.5	2.8	3.5	0.7	0.9	0.15	0.15	385	127	39	13	63 000	75 000	<b>F 602</b>	<b>F 602 ZZ</b>	—	—	3.2	3.8	0.15	0.15	0.60	0.71		<b>F 602</b>		
	8	9.5	9.5	2.8	4	0.7	0.9	0.15	0.15	550	175	56	18	60 000	71 000	<b>F 602 X</b>	<b>F 602 XZZ</b>	—	—	3.7	4.1	0.15	0.15	0.74	0.98		<b>F 602 X</b>		
3	6	7.1	7.1	1.8	2.6	0.5	0.8	0.08	0.08	208	74	21	7.5	71 000	80 000	<b>F 682 X</b>	<b>F 682 XZZ</b>	—	—	3.1	3.7	0.08	0.08	0.25	0.36	<b>F 682 X</b>			
	7	8.5	8.5	2.5	3.5	0.7	0.9	0.15	0.15	385	127	39	13	63 000	67 000	<b>F 692 X</b>	<b>F 692 XZZ</b>	—	—	3.7	3.8	0.15	0.15	0.51	0.68	<b>F 692 X</b>			
	8	9.2	—	2.5	—	0.6	—	0.2	—	560	179	57	18	60 000	71 000	<b>MF 82 X</b>	—	—	—	—	0.2	—	0.62	—	<b>MF 82 X</b>				
	8	9.5	9.5	2.8	4	0.7	0.9	0.15	0.15	550	175	56	18	60 000	71 000	<b>F 602 X</b>	<b>F 602 XZZ</b>	—	—	3.7	4.1	0.15	0.15	0.74	0.98	<b>F 602 X</b>			
3	6	7.2	7.2	2	2.5	0.6	0.6	0.1	0.1	208	74	21	7.5	71 000	80 000	<b>MF 63</b>	<b>MF 63 ZZ</b>	—	—	3.8	3.7	0.1	0.1	0.27	0.33	<b>MF 63</b>			
	7	8.1	8.1	2	3	0.5	0.8	0.1	0.1	390	130	40	13	63 000	75 000	<b>F 683 A</b>	<b>F 683 A ZZ</b>	—	—	3.8	4.0	0.1	0.1	0.37	0.53	<b>F 683 A</b>			
	8	9.2	—	2.5	—	0.6	—	0.15	—	560	179	57	18	60 000	67 000	<b>MF 83</b>	—	—	—	—	0.15	—	0.56	—	<b>MF 83</b>				
	8	9.5	9.5	3	4	0.7	0.9	0.15	0.15	560	179	57	18	60 000	67 000	<b>F 693</b>	<b>F 693 ZZ</b>	—	—	4.2	4.3	0.15	0.15	0.70	0.97	<b>F 693</b>			
4	9	10.2	10.6	2.5	4	0.6	0.8	0.2	0.15	570	187	58	19	56 000	67 000	<b>MF 93</b>	<b>MF 93 ZZ</b>	—	—	4.6	4.3	0.2	0.15	0.81	1.34	<b>MF 93</b>			
	9	10.5	10.5	3	5	0.7	1	0.15	0.15	570	187	58	19	56 000	67 000	<b>F 603</b>	<b>F 603 ZZ</b>	—	—	4.2	4.3	0.15	0.15	1.0	1.63	<b>F 603</b>			
	10	11.5	11.5	4	4	1	1	0.15	0.15	630	218	64	22	50 000	60 000	<b>F 623</b>	<b>F 623 ZZ</b>	—	—	4.2	4.3	0.15	0.15	1.85	1.86	<b>F 623</b>			
	13	15	15	5	5	1	1	0.2	0.2	1 300	485	133	49	36 000	43 000	<b>F 633</b>	<b>F 633 ZZ</b>	—	—	4.6	6.0	0.2	0.2	3.73	3.59	<b>F 633</b>			
	7	8.2	—	2	—	0.6	—	0.1	—	310	115	32	12	60 000	67 000	<b>MF 74</b>	—	—	—	—	0.1	—	0.29	—	<b>MF 74</b>				
	7	—	8.2	—	2.5	—	0.6	—	0.1	—	255	107	26	11	60 000	71 000	—	<b>MF 74 ZZ</b>	—	—	—	4.8	—	0.1	—	0.35		—	<b>MF 74</b>
	8	9.2	9.2	2	3	0.6	0.6	0.15	0.1	395	139	40	14	56 000	67 000	<b>MF 84</b>	<b>MF 84 ZZ</b>	—	—	5.2	5.0	0.15	0.1	0.44	0.63	<b>MF 84</b>			
9	10.3	10.3	2.5	4	0.6	1	(0.15)	(0.15)	640	225	65	23	53 000	63 000	<b>F 684</b>	<b>F 684 ZZ</b>	—	—	4.8	5.2	0.1	0.1	0.70	1.14	<b>F 684</b>				
10	11.2	11.6	3	4	0.6	0.8	0.2	0.15	710	270	73	28	50 000	60 000	<b>MF 104 B</b>	<b>MF 104 B ZZ</b>	—	—	5.6	5.9	0.2	0.15	1.13	1.59	<b>MF 104 B</b>				
11	12.5	12.5	4	4	1	1	0.15	0.15	960	345	98	35	48 000	56 000	<b>F 694</b>	<b>F 694 ZZ</b>	—	—	5.2	5.6	0.15	0.15	1.91	1.96	<b>F 694</b>				
12	13.5	13.5	4	4	1	1	0.2	0.2	960	345	98	35	48 000	56 000	<b>F 604</b>	<b>F 604 ZZ</b>	—	—	5.6	5.6	0.2	0.2	2.53	2.53	<b>F 604</b>				
13	15	15	5	5	1	1	0.2	0.2	1 300	485	133	49	40 000	48 000	<b>F 624</b>	<b>F 624 ZZ</b>	—	—	5.6	6.0	0.2	0.2	3.38	3.53	<b>F 624</b>				
16	18	18	5	5	1	1	0.3	0.3	1 730	670	177	68	36 000	43 000	<b>F 634</b>	<b>F 634 ZZ1</b>	—	—	6.0	7.5	0.3	0.3	5.73	5.65	<b>F 634</b>				

**Notes** <sup>(1)</sup> The values in parentheses are not based on ISO 15.

<sup>(2)</sup> Actual dimensions of bore and outside diameter only.

**Remarks** 1. When using bearings with a rotating outer ring, please contact NSK if they are shielded.  
 2. Bearings with double shields (ZZ, ZZ1) are also available with single shields (Z, Z1).



# Deep groove ball bearings with flanged outer ring

**Metric series**  
**F600, MF**  
**Bore diameter**  
**5 – 9 mm**

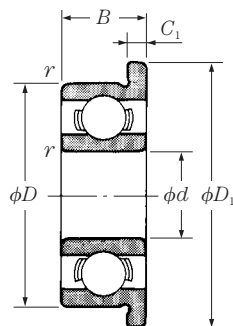

Open type

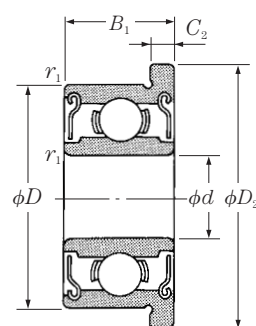

Shielded type  
ZZ · ZZ1

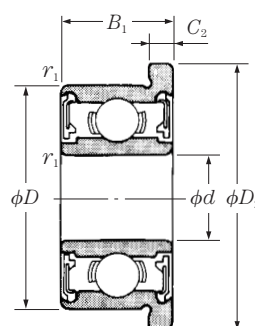

Non-contact  
sealed type  
VV

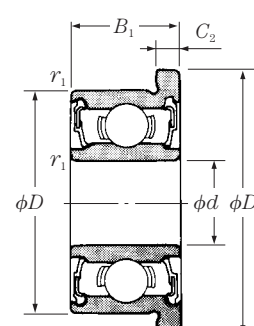

Contact sealed type  
DD

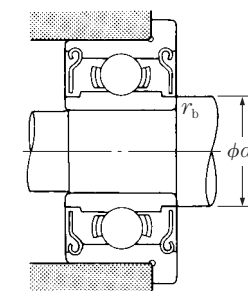
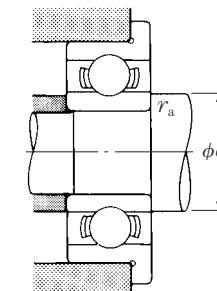

d	Boundary dimensions (mm)									Basic load ratings (N)				Limiting speeds (min <sup>-1</sup> )			Bearing numbers			Abutment and fillet dimensions (mm)				Mass (g)		Basic bearing numbers	Actual size <sup>(1)</sup>		
	D	D <sub>1</sub>	D <sub>2</sub>	B	B <sub>1</sub>	C <sub>1</sub>	C <sub>2</sub>	r min.	r <sub>1</sub> min.	C <sub>r</sub>	C <sub>or</sub>	C <sub>r</sub>	C <sub>or</sub>	Open Z·ZZ V·W	Grease D·DD	Oil Open Z	Open	Shielded	Sealed	d <sub>a</sub> min.	d <sub>b</sub> max.	r <sub>a</sub> max.	r <sub>b</sub> max.	Open approx.	Shielded approx.				
5	8	9.2	—	2	—	0.6	—	0.1	—	310	120	31	12	53 000	—	63 000	<b>MF 85</b>	—	—	—	5.8	—	0.1	—	0.33	—	<b>MF 85</b>		
	8	—	9.2	—	2.5	—	0.6	—	0.1	278	131	28	13	53 000	—	63 000	—	<b>MF 85 ZZ</b>	—	—	—	5.8	—	0.1	—	—	0.41		<b>MF 85</b>
	9	10.2	10.2	2.5	3	0.6	0.6	0.15	0.15	430	168	44	17	50 000	—	60 000	<b>MF 95</b>	—	—	—	6.2	6.0	0.15	0.15	0.59	0.66	<b>MF 95</b>		
	10	11.2	11.6	3	4	0.6	0.8	0.15	0.15	430	168	44	17	50 000	—	60 000	<b>MF 105</b>	—	—	—	6.2	6.0	0.15	0.15	1.05	1.46	<b>MF 105</b>		
	11	12.5	12.5	3	5	0.8	1	0.15	0.15	715	281	73	29	45 000	—	53 000	<b>F 685</b>	<b>F 685 ZZ</b>	—	—	—	6.2	6.2	0.15	0.15	1.37	2.18		<b>F 685</b>
13	15	15	4	4	1	1	0.2	0.2	1 080	430	110	44	43 000	40 000	50 000	<b>F 695</b>	<b>F 695 ZZ</b>	<b>VV</b>	<b>DD</b>	6.6	6.6	0.2	0.2	2.79	2.84	<b>F 695</b>			
14	16	16	5	5	1	1	0.2	0.2	1 330	505	135	52	40 000	38 000	50 000	<b>F 605</b>	<b>F 605 ZZ</b>	—	<b>DD</b>	6.6	6.9	0.2	0.2	3.9	3.85	<b>F 605</b>			
16	18	18	5	5	1	1	0.3	0.3	1 730	670	177	68	36 000	32 000	43 000	<b>F 625</b>	<b>F 625 ZZ1</b>	<b>VV</b>	<b>DD</b>	7.0	7.5	0.3	0.3	5.37	5.3	<b>F 625</b>			
19	22	22	6	6	1.5	1.5	0.3	0.3	2 340	885	238	90	32 000	30 000	40 000	<b>F 635</b>	<b>F 635 ZZ1</b>	<b>VV</b>	<b>DD</b>	7.0	8.5	0.3	0.3	9.49	9.49	<b>F 635</b>			
6	10	11.2	11.2	2.5	3	0.6	0.6	0.15	0.1	495	218	51	22	45 000	—	53 000	<b>MF 106</b>	<b>MF 106 ZZ1</b>	—	—	7.2	7.0	0.15	0.1	0.65	0.77	<b>MF 106</b>		
	12	13.2	13.6	3	4	0.6	0.8	0.2	0.15	715	292	73	30	43 000	40 000	50 000	<b>MF 126</b>	<b>MF 126 ZZ</b>	—	<b>DD</b>	7.6	7.2	0.2	0.15	1.38	1.94	<b>MF 126</b>		
	13	15	15	3.5	5	1	1.1	0.15	0.15	1 080	440	110	45	40 000	38 000	50 000	<b>F 686 A</b>	<b>F 686 A ZZ</b>	<b>VV</b>	<b>DD</b>	7.2	7.4	0.15	0.15	2.25	3.04	<b>F 686 A</b>		
	15	17	17	5	5	1.2	1.2	0.2	0.2	1 730	670	177	68	40 000	36 000	45 000	<b>F 696</b>	<b>F 696 ZZ1</b>	<b>VV</b>	<b>DD</b>	7.6	7.9	0.2	0.2	4.34	4.26	<b>F 696</b>		
	17	19	19	6	6	1.2	1.2	0.3	0.3	2 260	835	231	85	38 000	34 000	45 000	<b>F 606</b>	<b>F 606 ZZ</b>	<b>VV</b>	<b>DD</b>	8.0	8.2	0.3	0.3	6.58	6.61	<b>F 606</b>		
19	22	22	6	6	1.5	1.5	0.3	0.3	2 340	885	238	90	32 000	30 000	40 000	<b>F 626</b>	<b>F 626 ZZ1</b>	<b>VV</b>	<b>DD</b>	8.0	8.5	0.3	0.3	9.09	9.09	<b>F 626</b>			
22	25	25	7	7	1.5	1.5	0.3	0.3	3 300	1 370	335	140	30 000	28 000	36 000	<b>F 636</b>	<b>F 636 ZZ</b>	<b>VV</b>	<b>DD</b>	8.0	10.5	0.3	0.3	14.6	14.7	<b>F 636</b>			
7	11	12.2	12.2	2.5	3	0.6	0.6	0.15	0.1	455	201	47	21	43 000	—	50 000	<b>MF 117</b>	<b>MF 117 ZZ</b>	—	—	8.2	8.0	0.15	0.1	0.72	0.82	<b>MF 117</b>		
	13	14.2	14.6	3	4	0.6	0.8	0.2	0.15	540	276	55	28	40 000	—	48 000	<b>MF 137</b>	<b>MF 137 ZZ</b>	—	—	8.6	9.0	0.2	0.15	1.7	2.23	<b>MF 137</b>		
	14	16	16	3.5	5	1	1.1	0.15	0.15	1 170	510	120	52	40 000	34 000	45 000	<b>F 687</b>	<b>F 687 ZZ1</b>	<b>VV</b>	<b>DD</b>	8.2	8.5	0.15	0.15	2.48	3.37	<b>F 687</b>		
	17	19	19	5	5	1.2	1.2	0.3	0.3	1 610	710	164	73	36 000	28 000	43 000	<b>F 697</b>	<b>F 697 ZZ1</b>	<b>VV</b>	<b>DD</b>	9.0	10.2	0.3	0.3	5.65	5.65	<b>F 697</b>		
	19	22	22	6	6	1.5	1.5	0.3	0.3	2 340	885	238	90	36 000	32 000	43 000	<b>F 607</b>	<b>F 607 ZZ1</b>	<b>VV</b>	<b>DD</b>	9.0	9.1	0.3	0.3	8.66	8.66	<b>F 607</b>		
22	25	25	7	7	1.5	1.5	0.3	0.3	3 300	1 370	335	140	30 000	28 000	36 000	<b>F 627</b>	<b>F 627 ZZ</b>	<b>VV</b>	<b>DD</b>	9.0	10.5	0.3	0.3	14.2	14.2	<b>F 627</b>			
8	12	13.2	13.6	2.5	3.5	0.6	0.8	0.15	0.1	545	274	56	28	40 000	—	48 000	<b>MF 128</b>	<b>MF 128 ZZ1</b>	—	—	9.2	9.0	0.15	0.1	0.82	1.15	<b>MF 128</b>		
	14	15.6	15.6	3.5	4	0.8	0.8	0.2	0.15	820	385	83	39	38 000	32 000	45 000	<b>MF 148</b>	<b>MF 148 ZZ</b>	<b>VV</b>	<b>DD</b>	9.6	9.2	0.2	0.15	2.09	2.39	<b>MF 148</b>		
	16	18	18	4	5	1	1.1	0.2	0.2	1 610	710	164	73	36 000	30 000	43 000	<b>F 688 A</b>	<b>F 688 A ZZ1</b>	<b>VV</b>	<b>DD</b>	9.6	10.2	0.2	0.2	3.54	4.47	<b>F 688 A</b>		
	19	22	22	6	6	1.5	1.5	0.3	0.3	2 240	910	228	93	36 000	28 000	43 000	<b>F 698</b>	<b>F 698 ZZ</b>	<b>VV</b>	<b>DD</b>	10.0	10.0	0.3	0.3	8.35	8.3	<b>F 698</b>		
	22	25	25	7	7	1.5	1.5	0.3	0.3	3 300	1 370	335	140	34 000	28 000	40 000	<b>F 608</b>	<b>F 608 ZZ</b>	<b>VV</b>	<b>DD</b>	10.0	10.5	0.3	0.3	13.4	13.5	<b>F 608</b>		
9	17	19	19	4	5	1	1.1	0.2	0.2	1 330	665	136	68	36 000	24 000	43 000	<b>F 689</b>	<b>F 689 ZZ1</b>	<b>VV</b>	<b>DD</b>	10.6	11.5	0.2	0.2	3.97	4.91	<b>F 689</b>		
	20	23	23	6	6	1.5	1.5	0.3	0.3	1 720	840	175	86	34 000	24 000	40 000	<b>F 699</b>	<b>F 699 ZZ1</b>	<b>VV</b>	<b>DD</b>	11.0	12.0	0.3	0.3	9.51	9.51	<b>F 699</b>		

**Note** <sup>(1)</sup> Actual dimensions of bore and outside diameter only.

**Remarks** 1. When using bearings with a rotating outer ring, please contact NSK if they are shielded.  
 2. Bearings with double shields (ZZ, ZZ1) are also available with single shields (Z, Z1).

# Deep groove ball bearings with flanged outer ring

Inch series  
FR  
Bore diameter  
1.191 – 9.525 mm

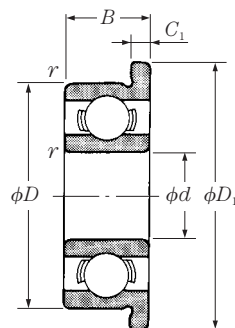

Open type

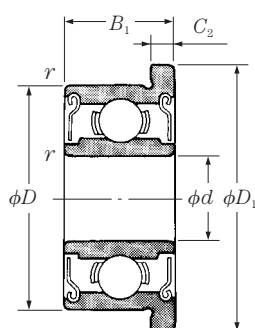

Shielded type  
ZZ · ZJS

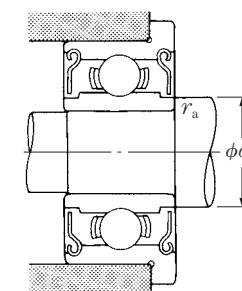
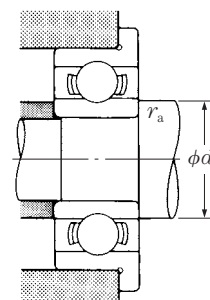

d	Boundary dimensions (mm/inch)												Basic load ratings (N) {kgf}				Limiting speeds (min <sup>-1</sup> )		Bearing numbers		Abutment and fillet dimensions (mm)			Mass (g)		Basic bearing numbers	Actual size <sup>(1)</sup>
	D	D <sub>1</sub>	B	B <sub>1</sub>	C <sub>1</sub>	C <sub>2</sub>	r min.	C <sub>r</sub>	C <sub>or</sub>	C <sub>r</sub>	C <sub>or</sub>	Grease Open Z-ZZ	Oil Open Z	Open	Shielded	d <sub>a</sub> min.	d <sub>b</sub> max.	r <sub>a</sub> max.	Open	Shielded approx.							
1.191	3.967	5.156	1.588	2.380	0.330	0.013	0.1	138	35	14	3.5	110 000	130 000	FR 0	FR 0 ZZ	2.0	1.9	0.1	0.11	0.16	FR 0						
1.397	4.762	5.944	1.984	2.779	0.580	0.023	0.1	231	66	24	6.5	90 000	110 000	FR 1	FR 1 ZZ	2.2	2.3	0.1	0.20	0.25	FR 1						
1.984	6.350	7.518	2.380	3.571	0.580	0.023	0.1	310	108	32	11	67 000	80 000	FR 1-4	FR 1-4 ZZ	2.8	3.9	0.1	0.41	0.58	FR 1-4						
2.380	4.762	5.944	1.588	—	0.460	0.018	0.1	188	60	19	6	80 000	95 000	FR 133	—	3.2	—	0.1	0.13	—	FR 133						
	4.762	5.944	—	2.380	—	—	0.1	143	52	15	5.5	80 000	95 000	—	FR 133 ZJS	—	3.0	0.1	—	0.19	FR 133						
	7.938	9.119	2.779	3.571	0.580	0.023	0.15	550	175	56	18	60 000	71 000	FR 1-5	FR 1-5 ZZ	3.6	4.1	0.15	0.68	0.82	FR 1-5						
3.175	6.350	7.518	2.380	2.779	0.580	0.023	0.1	283	95	29	9.5	67 000	80 000	FR 144	FR 144 ZZ	4.0	3.9	0.1	0.31	0.35	FR 144						
	7.938	9.119	2.779	3.571	0.580	0.023	0.1	560	179	57	18	60 000	67 000	FR 2-5	FR 2-5 ZZ	4.0	4.3	0.1	0.62	0.81	FR 2-5						
	9.525	10.719	2.779	3.571	0.580	0.023	0.15	640	225	65	23	53 000	63 000	FR 2-6	FR 2-6 ZJS	4.4	4.6	0.15	1.04	1.25	FR 2-6						
	9.525	11.176	3.967	3.967	0.760	0.030	0.3	630	218	64	22	56 000	67 000	FR 2	FR 2 ZZ	5.2	4.8	0.3	1.51	1.55	FR 2						
3.967	7.938	9.119	2.779	3.175	0.580	0.023	0.1	360	149	37	15	53 000	63 000	FR 155	FR 155 ZJS	4.8	5.5	0.1	0.59	0.67	FR 155						
4.762	7.938	9.119	2.779	3.175	0.580	0.023	0.1	360	149	37	15	53 000	63 000	FR 156	FR 156 ZJS	5.6	5.5	0.1	0.47	0.53	FR 156						
	9.525	10.719	3.175	3.175	0.580	0.023	0.1	710	270	73	28	50 000	60 000	FR 166	FR 166 ZZ	5.6	5.9	0.1	0.90	0.98	FR 166						
	12.700	14.351	4.978	4.978	1.070	0.042	0.3	1 300	485	133	49	43 000	53 000	FR 3	FR 3 ZZ	6.8	6.5	0.3	2.97	3.09	FR 3						
6.350	9.525	10.719	3.175	3.175	0.580	0.023	0.1	420	204	43	21	48 000	56 000	FR 168 B	FR 168 BZZ	7.2	7.0	0.1	0.66	0.75	FR 168 B						
	12.700	13.894	3.175	4.762	0.580	0.023	0.15	1 080	440	110	45	40 000	50 000	FR 188	FR 188 ZZ	7.6	7.4	0.15	1.64	2.49	FR 188						
	15.875	17.526	4.978	4.978	1.070	0.042	0.3	1 610	660	164	68	38 000	45 000	FR 4 B	FR 4 BZZ	8.4	8.4	0.3	4.78	4.78	FR 4 B						
7.938	12.700	13.894	3.967	3.967	0.790	0.031	0.15	540	276	55	28	40 000	48 000	FR 1810	FR 1810 ZZ	9.2	9.0	0.15	1.71	1.63	FR 1810						
9.525	22.225	24.613	7.142	7.142	1.570	0.062	0.4	3 350	1 410	340	144	32 000	38 000	FR 6	FR 6 ZZ	12.6	11.9	0.4	10.1	12.1	FR 6						

Note <sup>(1)</sup> Actual dimensions of bore and outside diameter only.

Remarks 1. When using bearings with a rotating outer ring, please contact NSK if they are shielded.  
2. Bearings with double shields (ZZ, ZJS) are also available with single shields (Z, ZS).



# Deep groove ball bearings with extended inner ring

Inch series  
**RW**  
 Bore diameter  
**1.016 – 9.525 mm**

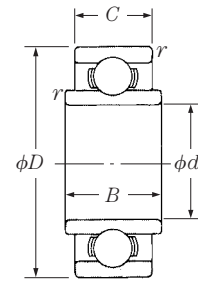

Open type

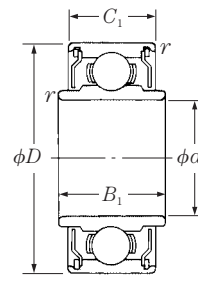

Shielded type  
 ZZ · ZJS

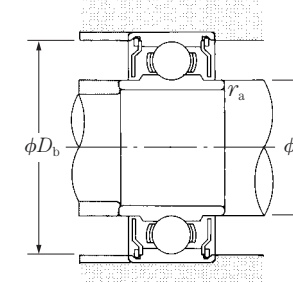
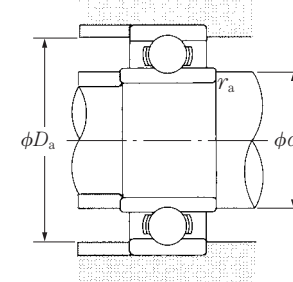

d	Boundary dimensions (mm/inch)											Basic load ratings (N) (kgf)				Limiting speeds (min <sup>-1</sup> )		Bearing numbers		Abutment and fillet dimensions (mm)					Mass (g)		Basic bearing numbers	Actual size <sup>(1)</sup>	
	D	B	B <sub>1</sub>	C	C <sub>1</sub>	r min.	C <sub>r</sub>	C <sub>or</sub>	C <sub>r</sub>	C <sub>or</sub>	Grease Open Z·ZZ	Oil Open Z	Open	Shielded	d <sub>a</sub> min.	d <sub>b</sub> max.	D <sub>a</sub> max.	D <sub>b</sub> min.	r <sub>a</sub> max.	Open approx.	Shielded approx.								
1.016	0.0400	3.175	0.1250	1.984	0.0781	—	—	1.191	0.0469	—	—	0.1	80	23	8	2.5	130 000	150 000	<b>RW 09</b>	—	1.9	—	2.3	—	0.1	0.05	—	<b>RW 09</b>	
1.191	0.0469	3.967	0.1562	2.380	0.0937	3.175	0.1250	1.588	0.0625	2.380	0.0937	0.1	138	35	14	3.5	110 000	130 000	<b>RW 0</b>	<b>RW 0 ZZ</b>	2.0	1.9	3.1	3.5	0.1	0.11	0.16	<b>RW 0</b>	
1.397	0.0550	4.762	0.1875	2.779	0.1094	3.571	0.1406	1.984	0.0781	2.779	0.1094	0.1	231	66	24	6.5	90 000	110 000	<b>RW 1</b>	<b>RW 1 ZZ</b>	2.2	2.3	3.9	4.1	0.1	0.17	0.25	<b>RW 1</b>	
1.984	0.0781	6.350	0.2500	3.175	0.1250	4.366	0.1719	2.380	0.0937	3.571	0.1406	0.1	310	108	32	11	67 000	80 000	<b>RW 1-4</b>	<b>RW 1-4 ZZ</b>	2.8	3.9	5.5	5.9	0.1	0.46	0.46	<b>RW 1-4</b>	
2.380	0.0937	4.762	0.1875	2.380	0.0937	—	—	1.588	0.0625	—	—	0.1	188	60	19	6	80 000	95 000	<b>RW 133</b>	—	3.2	—	3.9	—	0.1	0.12	—	<b>RW 133</b>	
	4.762	0.1875	—	—	3.175	0.1250	—	—	2.380	0.0937	0.1	143	52	15	5.5	80 000	95 000	—	<b>RW 133 ZZS</b>	—	3.0	—	4.2	0.1	—	0.17	—	<b>RW 133</b>	
	7.938	0.3125	3.571	0.1406	4.366	0.1719	2.779	0.1094	3.571	0.1406	0.15	550	175	56	18	60 000	71 000	<b>RW 1-5</b>	<b>RW 1-5 ZZ</b>	3.6	4.1	6.7	7.0	0.15	0.63	0.73	<b>RW 1-5</b>		
3.175	0.1250	6.350	0.2500	3.175	0.1250	3.571	0.1406	2.380	0.0937	2.779	0.1094	0.1	283	95	29	9.5	67 000	80 000	<b>RW 144</b>	<b>RW 144 ZZ</b>	4.0	3.9	5.5	5.9	0.1	0.30	0.33	<b>RW 144</b>	
	7.983	0.3125	3.571	0.1406	4.366	0.1719	2.779	0.1094	3.571	0.1406	0.1	560	179	57	18	60 000	67 000	<b>RW 2-5</b>	<b>RW 2-5 ZZ</b>	4.0	4.3	7.1	7.3	0.1	0.74	0.74	<b>RW 2-5</b>		
	9.525	0.3750	3.571	0.1406	4.366	0.1719	2.779	0.1094	3.571	0.1406	0.15	640	225	65	23	53 000	63 000	<b>RW 2-6</b>	<b>RW 2-6 ZZS</b>	4.4	4.6	8.3	8.2	0.15	1.0	1.1	<b>RW 2-6</b>		
	9.525	0.3750	4.762	0.1875	4.762	0.1875	3.967	0.1562	3.967	0.1562	0.3	630	218	64	22	56 000	67 000	<b>RW 2</b>	<b>RW 2 ZZ</b>	5.2	4.8	7.5	8.0	0.3	1.4	1.3	<b>RW 2</b>		
3.967	0.1562	7.938	0.3125	3.571	0.1406	3.967	0.1562	2.779	0.1094	3.175	0.1250	0.1	360	149	37	15	53 000	63 000	<b>RW 155</b>	<b>RW 155 ZZS</b>	4.8	5.5	7.1	7.3	0.1	0.56	0.62	<b>RW 155</b>	
4.762	0.1875	7.938	0.3125	3.571	0.1406	3.967	0.1562	2.779	0.1094	3.175	0.1250	0.1	360	149	37	15	53 000	63 000	<b>RW 156</b>	<b>RW 156 ZZS</b>	5.6	5.5	7.1	7.3	0.1	0.44	0.49	<b>RW 156</b>	
	9.525	0.3750	3.967	0.1562	3.967	0.1562	3.175	0.1250	3.175	0.1250	0.1	710	270	73	28	50 000	60 000	<b>RW 166</b>	<b>RW 166 ZZ</b>	5.6	5.9	8.7	8.8	0.1	0.82	0.87	<b>RW 166</b>		
	12.700	0.5000	4.762	0.1875	5.771	0.2272	3.967	0.1562	4.978	0.1960	0.3	1 300	485	133	49	43 000	53 000	<b>RW 3</b>	<b>RW 3 ZZ</b>	6.8	6.5	10.7	11.2	0.3	2.33	2.90	<b>RW 3</b>		
6.350	0.2500	9.525	0.3750	3.967	0.1562	3.967	0.1562	3.175	0.1250	3.175	0.1250	0.1	420	204	43	21	48 000	56 000	<b>RW 168 B</b>	<b>RW 168 BZZ</b>	7.2	7.0	8.7	8.9	0.1	0.62	0.66	<b>RW 168 B</b>	
	12.700	0.5000	3.967	0.1562	5.558	0.2188	3.175	0.1250	4.762	0.1875	0.15	1 080	440	110	45	40 000	50 000	<b>RW 188</b>	<b>RW 188 ZZ</b>	7.6	7.4	11.5	11.6	0.15	1.7	2.1	<b>RW 188</b>		
	15.875	0.6250	5.771	0.2272	5.771	0.2272	4.978	0.1960	4.978	0.1960	0.3	1 610	660	164	68	38 000	45 000	<b>RW 4 B</b>	<b>RW 4 BZZ</b>	8.4	8.4	13.8	13.8	0.3	4.72	4.62	<b>RW 4 B</b>		
7.938	0.3125	12.700	0.5000	4.762	0.1875	4.762	0.1875	3.967	0.1562	3.967	0.1562	0.15	540	276	55	28	40 000	48 000	<b>RW 1810</b>	<b>RW 1810 ZZ</b>	9.2	9.0	11.5	11.6	0.15	1.9	1.6	<b>RW 1810</b>	
9.525	0.3750	22.225	0.8750	7.142	0.2812	—	—	5.558	0.2188	—	—	0.4	3 350	1 410	340	144	32 000	38 000	<b>RW 6</b>	—	12.6	—	19.2	—	0.4	10	—	<b>RW 6</b>	

Note <sup>(1)</sup> Actual dimensions of bore and outside diameter only.

Remarks 1. When using bearings with a rotating outer ring, please contact NSK if they are shielded.  
 2. Bearings with double shields (ZZ, ZZS) are also available with single shields (Z, ZS).

# Deep groove ball bearings with extended inner ring, flanged

Inch series  
FRW  
Bore diameter  
1.191 – 7.938 mm

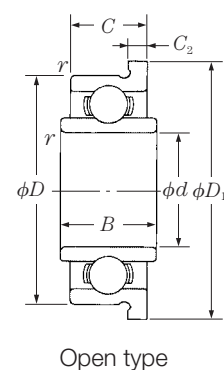

Open type

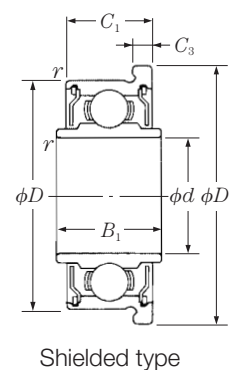

Shielded type  
ZZ · ZJS

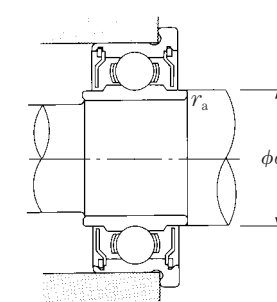
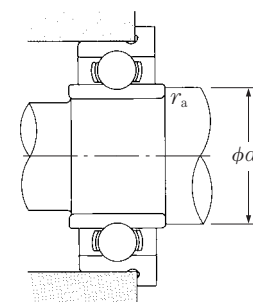

d	Boundary dimensions (mm/inch)										Basic load ratings (N) (kgf)				Limiting speeds (min <sup>-1</sup> )		Bearing numbers		Abutment and fillet dimensions (mm)			Mass (g)		Basic bearing numbers	Actual size <sup>(1)</sup>	
	D	D <sub>1</sub>	B	B <sub>1</sub>	C	C <sub>1</sub>	C <sub>2</sub>	C <sub>3</sub>	r min.	C <sub>r</sub>	C <sub>or</sub>	C <sub>r</sub>	C <sub>or</sub>	Grease Open Z·ZZ	Oil Open Z	Open	Shielded	d <sub>a</sub> min.	d <sub>b</sub> max.	r <sub>a</sub> max.	Open	Shielded approx.				
1.191	3.967	5.156	2.380	3.175	1.588	2.380	0.330	0.013	0.790	0.031	0.1	138	35	14	3.5	110 000	130 000	FRW 0	FRW 0 ZZ	2.0	1.9	0.1	0.14	0.19	FRW 0	
1.397	4.762	5.944	2.779	3.571	1.984	2.779	0.580	0.023	0.790	0.031	0.1	231	66	24	6.5	90 000	110 000	FRW 1	FRW 1 ZZ	2.2	2.3	0.1	0.24	0.32	FRW 1	
1.984	6.350	7.518	3.175	4.366	2.380	3.571	0.580	0.023	0.790	0.031	0.1	310	108	32	11	67 000	80 000	FRW 1-4	FRW 1-4 ZZ	2.8	3.9	0.1	0.59	0.59	FRW 1-4	
2.380	4.762	5.944	2.380	—	1.588	—	—	—	—	—	0.1	188	60	19	6	80 000	95 000	FRW 133	—	3.2	—	0.1	0.17	—	FRW 133	
	4.762	5.944	—	—	—	—	—	—	—	—	0.1	143	52	15	5.5	80 000	95 000	—	FRW 133 ZJS	—	3.0	0.1	—	0.22	FRW 133	
	7.938	9.119	3.571	4.366	2.779	3.571	0.580	0.023	0.790	0.031	0.15	550	175	56	18	60 000	71 000	FRW 1-5	FRW 1-5 ZZ	3.6	4.1	0.15	0.83	0.93	FRW 1-5	
3.175	6.350	7.518	3.175	3.571	2.380	2.779	0.580	0.023	0.790	0.031	0.1	283	95	29	9.5	67 000	80 000	FRW 144	FRW 144 ZZ	4.0	3.9	0.1	0.44	0.47	FRW 144	
	7.938	9.119	3.571	4.366	2.779	3.571	0.580	0.023	0.790	0.031	0.1	560	179	57	18	60 000	67 000	FRW 2-5	FRW 2-5 ZZ	4.0	4.3	0.1	0.93	0.93	FRW 2-5	
	9.525	10.719	3.571	4.366	2.779	3.571	0.580	0.023	0.790	0.031	0.15	640	225	65	23	53 000	63 000	FRW 2-6	FRW 2-6 ZJS	4.4	4.6	0.15	1.3	1.4	FRW 2-6	
	9.525	11.176	4.40	4.762	3.967	3.967	0.760	0.030	0.760	0.030	0.3	630	218	64	22	56 000	67 000	FRW 2	FRW 2 ZZ	5.2	4.8	0.3	1.8	1.7	FRW 2	
3.967	7.938	9.119	3.571	3.967	2.779	3.175	0.580	0.023	0.910	0.036	0.1	360	149	37	15	53 000	63 000	FRW 155	FRW 155 ZJS	4.8	5.5	0.1	0.73	0.79	FRW 155	
4.762	7.938	9.119	3.571	3.967	2.779	3.175	0.580	0.023	0.910	0.036	0.1	360	149	37	15	53 000	63 000	FRW 156	FRW 156 ZJS	5.6	5.5	0.1	0.58	0.63	FRW 156	
	9.525	10.719	3.967	3.967	3.175	3.175	0.580	0.023	0.790	0.031	0.1	710	270	73	28	50 000	60 000	FRW 166	FRW 166 Z	5.6	5.9	0.1	1.2	1.2	FRW 166	
	12.700	14.351	5.65	4.762	3.967	4.978	1.070	0.042	1.070	0.042	0.3	1 300	485	133	49	43 000	53 000	FRW 3	FRW 3 ZZ	6.8	6.5	0.3	3.1	3.2	FRW 3	
6.350	9.525	10.719	3.967	3.967	3.175	3.175	0.580	0.023	0.910	0.036	0.1	420	204	43	21	48 000	56 000	FRW 168 B	FRW 168 BZZ	7.2	7.0	0.1	0.70	0.79	FRW 168 B	
	12.700	13.894	5.47	3.967	3.175	4.762	0.580	0.023	1.140	0.045	0.15	1 080	440	110	45	40 000	50 000	FRW 188	FRW 188 ZZ	7.6	7.4	0.15	2.1	2.5	FRW 188	
	15.875	17.526	6.90	5.771	4.978	4.978	1.070	0.042	1.070	0.042	0.3	1 610	660	164	68	38 000	45 000	FRW 4 B	FRW 4 BZZ	8.4	8.4	0.3	5.08	4.98	FRW 4 B	
7.938	12.700	13.894	4.762	4.762	3.967	3.967	0.790	0.031	0.790	0.031	0.15	540	276	55	28	40 000	48 000	FRW 1810	FRW 1810 ZZ	9.2	9.0	0.15	2.3	2.1	FRW 1810	

Note <sup>(1)</sup> Actual dimensions of bore and outside diameter only.

Remarks 1. When using bearings with a rotating outer ring, please contact NSK if they are shielded.  
2. Bearings with double shields (ZZ, ZJS) are also available with single shields (Z, ZS).



Inch series

SR · · X

Bore diameter

3.175 – 4.762 mm

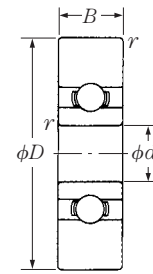

Open type

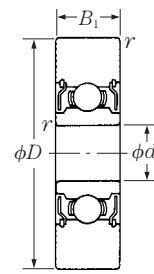

Shielded type  
ZZS

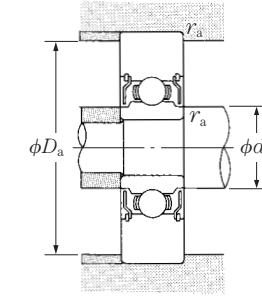
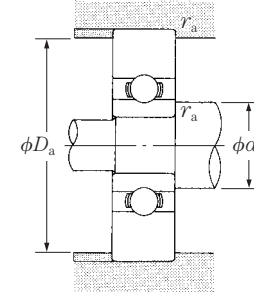

<i>d</i>	Boundary dimensions (mm/inch)				Basic load ratings (N) {kgf}				Limiting speeds (min <sup>-1</sup> )		Bearing numbers			Abutment and fillet dimensions (mm)				Mass (g) approx.	
	<i>D</i>	<i>B</i>	<i>B</i> <sub>1</sub>	<i>r</i> <sub>min.</sub>	<i>C</i> <sub>r</sub>	<i>C</i> <sub>or</sub>	<i>C</i> <sub>r</sub>	<i>C</i> <sub>or</sub>	Grease Open ZS·ZZS	Oil Open ZS	Open	Single shielded	Double shielded	<i>d</i> <sub>a</sub> min.	<i>d</i> <sub>b</sub> max.	<i>D</i> <sub>a</sub> max.	<i>r</i> <sub>a</sub> max.		
<b>3.175</b> 0.1250	9.525 0.3750	—	—	2.779 0.1094	0.1	241	76	25	8.0	53 000	63 000	—	<b>SR 2X52 ZS</b>	<b>SR 2X52 ZZS</b>	3.9	3.9	8.7	0.1	1.0
	10.100 0.3976	—	—	2.380 0.0937	0.1	264	87	27	9.0	63 000	75 000	—	<b>SR 144X100 ZS</b>	<b>SR 144X100 ZZS</b>	3.9	3.9	9.3	0.1	1.2
	10.414 0.4100	—	—	2.380 0.0937	0.1	264	87	27	9.0	63 000	75 000	—	<b>SR 174X5 ZS</b>	<b>SR 174X5 ZZS</b>	3.9	3.9	9.6	0.1	1.2
<b>4.762</b> 0.1875	10.100 0.3976	—	—	2.779 0.1094	0.1	305	119	31	12	53 000	63 000	—	<b>SR 156X100 ZS</b>	<b>SR 156X100 ZZS</b>	5.5	5.5	9.3	0.1	1.0
	10.414 0.4100	—	—	2.779 0.1094	0.1	305	119	31	12	53 000	63 000	—	<b>SR 156X101 ZS</b>	<b>SR 156X101 ZZS</b>	5.5	5.5	9.6	0.1	1.1
	12.700 0.5000	2.779	0.1094	—	—	605	216	62	22	50 000	60 000	<b>SR 186X1</b>	—	—	5.6	—	11.9	0.1	1.8
	12.700 0.5000	—	—	3.967 0.1562	0.1	605	216	62	22	50 000	60 000	—	<b>SR 186X2 ZS</b>	<b>SR 186X2 ZZS</b>	5.6	5.9	11.9	0.1	2.6
	14.463 0.5694	4.978	0.1960	4.978 0.1960	0.3	1 110	385	113	40	43 000	53 000	<b>SR 3X31</b>	<b>SR 3X31 ZS</b>	<b>SR 3X31 ZZS</b>	6.5	6.5	12.9	0.3	4.0
	22.225 0.8750	4.978	0.1960	4.978 0.1960	0.3	1 260	495	128	50	43 000	53 000	<b>SR 3X23</b>	<b>SR 3X23 ZS</b>	<b>SR 3X23 ZZS</b>	6.8	8.4	20.6	0.3	13

**Remark** These bearings are made of stainless steel.

**Metric series**  
**700C**  
**Bore diameter**  
**4 – 9 mm**

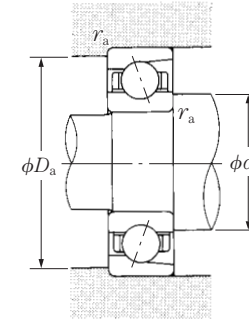
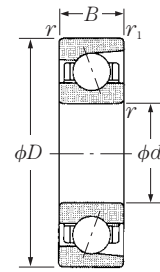

d	Boundary dimensions (mm)				Basic load ratings (N) {kgf}				Limiting speeds (min <sup>-1</sup> )		Bearing numbers	Abutment and fillet dimensions (mm)			Mass (g) approx.
	D	B	r min.	r <sub>1</sub> min.	C <sub>r</sub>	C <sub>or</sub>	C <sub>r</sub>	C <sub>or</sub>	Grease	Oil		d <sub>a</sub> min.	D <sub>a</sub> max.	r <sub>a</sub> max.	
4	16	5	0.3	0.15	1 700	660	174	67	53 000	71 000	<b>734C</b>	6.5	13.5	0.3	5.3
5	16	5	0.3	0.15	1 700	660	174	66	53 000	71 000	<b>725C</b>	7.5	13.5	0.3	4.5
6	17	6	0.3	0.15	2 030	795	204	81	50 000	67 000	<b>706C</b>	8.5	14.5	0.3	5.5
	19	6	0.3	0.15	2 390	1 000	243	102	48 000	63 000	<b>726C</b>	8.5	16.5	0.3	7.8
7	19	6	0.3	0.15	2 390	1 000	243	102	48 000	63 000	<b>707C</b>	9.5	16.5	0.3	7.4
8	22	7	0.3	0.15	3 550	1 540	360	157	43 000	56 000	<b>708C</b>	10.5	19.5	0.3	12
	24	8	0.3	0.15	3 600	1 600	365	164	40 000	53 000	<b>728C</b>	10.5	21.5	0.3	16
9	24	7	0.3	0.15	3 600	1 600	365	164	40 000	53 000	<b>709C</b>	11.5	21.5	0.3	14

**Remarks** 1. The tolerance classes for this type of bearing are classes 5 and 4.  
 2. Please contact NSK regarding separable bearings or inch series bearings.

## Extra-thin-section deep groove ball bearings

**Metric series**  
**SMT**  
**Bore diameter**  
**10 – 15 mm**

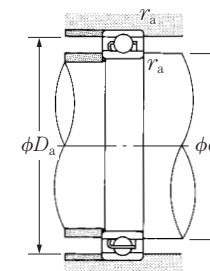
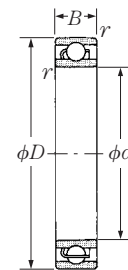

d	Boundary dimensions (mm)			Basic load ratings (N) {kgf}				Limiting speeds (min <sup>-1</sup> )		Bearing numbers	Abutment and fillet dimensions (mm)			Mass (g) approx.
	D	B	r min.	C <sub>r</sub>	C <sub>or</sub>	C <sub>r</sub>	C <sub>or</sub>	Grease	Oil		d <sub>a</sub> min.	D <sub>a</sub> max.	r <sub>a</sub> max.	
10	15	3	0.15	815	410	83	42	36 000	43 000	<b>SMT 1510</b>	11.2	13.8	0.15	1.4
15	20	3.5	0.15	800	470	82	48	30 000	36 000	<b>SMT 2015</b>	16.2	18.8	0.15	2.2

**Remarks** 1. These bearings are made of stainless steel.  
 2. The tolerance classes for this type of bearing are normal and class 6.  
 3. The radial internal clearance for this type of bearing is specified by ISO 5593 Rolling bearings-Radial internal clearance.

## Appendices

	Page
<b>Appendix Table 1 Conversion from SI (International Units) system</b> .....	54 – 55
<b>Appendix Table 2 N – kgf Force conversion table</b> .....	56
<b>Appendix Table 3 Kg – lb Mass conversion table</b> .....	57
<b>Appendix Table 4 °C – °F Temperature conversion table</b> .....	58
<b>Appendix Table 5 Viscosity conversion table</b> .....	59
<b>Appendix Table 6 Inch-mm Dimension conversion table</b> .....	60
<b>Appendix Table 7 Hardness conversion table</b> .....	61
<b>Appendix Table 8 Values of standard tolerance grades IT</b> ...	62 – 63
<b>Appendix Table 9 Physical and mechanical properties of materials</b> .....	64



Appendix Table 1 Conversion from SI (International Units) System

Comparison of SI, CGS, and Engineering Units

Unit System	Units				Acceleration	Force	Stress	Pressure	Energy	Power
	Length	Mass	Time	Temp.						
SI	m	kg	s	K	m/s <sup>2</sup>	N	Pa	Pa	J	W
CGS System	cm	g	s	°C	Gal	dyn	dyn/cm <sup>2</sup>	dyn/cm <sup>2</sup>	erg	erg/s
Engineering Unit System	m	kgf·s <sup>2</sup> /m	s	°C	m/s <sup>2</sup>	kgf	kgf/m <sup>2</sup>	kgf/m <sup>2</sup>	kgf·m	kgf·m/s

Prefixes Used In SI System

Multiples			Multiples		
Prefix	Symbols		Prefix	Symbols	
10 <sup>18</sup>	Exa	E	10 <sup>-1</sup>	Deci	d
10 <sup>15</sup>	Peta	P	10 <sup>-2</sup>	Centi	c
10 <sup>12</sup>	Tera	T	10 <sup>-3</sup>	Milli	m
10 <sup>9</sup>	Giga	G	10 <sup>-6</sup>	Micro	μ
10 <sup>6</sup>	Mega	M	10 <sup>-9</sup>	Nano	n
10 <sup>3</sup>	Kilo	k	10 <sup>-12</sup>	Pico	p
10 <sup>2</sup>	Hecto	h	10 <sup>-15</sup>	Femto	f
10	Deca	da	10 <sup>-18</sup>	Ato	a

Conversion Factors from SI Units

Parameter	SI Units		Units other than SI		Conversion Factors from SI Units
	Names of Units	Symbols	Name of Units	Symbols	
Angle	Radian	rad	Degree	°	180/π
			Minute	'	10 800/π
			Second	"	648 000/π
Length	Meter	m	Micron	μ	10 <sup>6</sup>
			Angstrom	Å	10 <sup>10</sup>
Area	Square meter	m <sup>2</sup>	Are	a	10 <sup>-2</sup>
			Hectare	ha	10 <sup>-4</sup>
Volume	Cubic meter	m <sup>3</sup>	Liter	l, L	10 <sup>3</sup>
			Deciliter	dl, dL	10 <sup>4</sup>
Time	Second	s	Minute	min	1/60
			Hour	h	1/3 600
			Day	d	1/86 400
Frequency	Hertz	Hz	Cycle	s <sup>-1</sup>	1
Speed of Rotation	Revolution per second	s <sup>-1</sup>	Revolution per minute	rpm	60
Speed	Meter per second	m/s	Kilometer per hour	km/h	3 600/1 000
			Knot	kn	3 600/1 852
Acceleration	Meter per second per second	m/s <sup>2</sup>	Gal	Gal	10 <sup>2</sup>
			g	g	1/9.806 65
Mass	Kilogram	kg	Ton	t	10 <sup>-3</sup>
Force	Newton	N	Kilogram-force	kgf	1/9.806 65
			Ton-force	tf	1/(9.806 65 × 10 <sup>3</sup> )
			Dyne	dyn	10 <sup>5</sup>
Torque or Moment	Newton · meter	N · m	Kilogram-force meter	kgf · m	1/9.806 65
Stress	Pascal	Pa (N/m <sup>2</sup> )	Kilogram-force per square centimeter	kgf/cm <sup>2</sup>	1/(9.806 65 × 10 <sup>4</sup> )
			Kilogram-force per square millimeter	kgf/mm <sup>2</sup>	1/(9.806 65 × 10 <sup>6</sup> )

Conversion Factors from SI Units (Continued)

Parameter	SI Units		Units other than SI		Conversion factors from SI Units
	Names of Units	Symbols	Names of Units	Units	
Pressure	Pascal (Newton per square meter)	Pa (N/m <sup>2</sup> )	Kilogram-force per square meter	kgf/m <sup>2</sup>	1/9.806 65
			Water Column	mH <sub>2</sub> O	1/(9.806 65 × 10 <sup>3</sup> )
			Mercury Column	mmHg	760/(1.013 25 × 10 <sup>5</sup> )
			Torr	Torr	760/(1.013 25 × 10 <sup>5</sup> )
			Bar	bar	10 <sup>5</sup>
			Atmosphere	atm	1/(1.013 25 × 10 <sup>5</sup> )
Energy	Joule (Newton · meter)	J (N·m)	Erg	erg	10 <sup>7</sup>
			Calorie (International)	cal <sub>IT</sub>	1/4.186 8
			Kilogram-force meter	kgf·m	1/9.806 65
			Kilowatt hour	kW·h	1/(3.6 × 10 <sup>6</sup> )
French horse power hour	PS·h	≈3.776 72 × 10 <sup>-7</sup>			
Work	Watt (Joule per second)	W (J/s)	Kilogram-force meter per second	kgf·m/s	1/9.806 65
			Kilocalorie per hour	kcal/h	1/1.163
			French horse power	PS	≈1/735.498 8
Viscosity, Viscosity Index	Pascal second	Pa·s	Poise	P	10
			Kinematic Viscosity, Kinematic Viscosity Index	Square meter per second	m <sup>2</sup> /s
			Centistokes	cSt	10 <sup>6</sup>
Temperature	Kelvin, Degree celsius	K, °C	Degree	°C	(See Note <sup>(1)</sup> )
Electric Current, Magnetomotive Force	Ampere	A	Ampere	A	1
Voltage, Electromotive Force	Volt	V	(Watts per ampere)	(W/A)	1
Magnetic Field Strength	Ampere per meter	A/m	Oersted	Oe	4π/10 <sup>3</sup>
Magnetic Flux Density	Tesla	T	Gauss	Gs	10 <sup>4</sup>
			Gamma	γ	10 <sup>9</sup>
Electrical Resistance	Ohm	Ω	(Volts per ampere)	(V/A)	1

**Note** <sup>(1)</sup> The conversion from TK into θ °C is θ = T-273.15 but for a temperature difference, it is ΔT = Δθ. However, ΔT and Δθ represent temperature differences measured using the Kelvin and Celsius scales respectively.

**Remarks** The names and symbols in ( ) are equivalent to those directly above them or on their left. Example of conversion 1 N = 1/9.806 65 kgf

Appendix Table 2 N - kgf Conversion Table

How to use this table

For example, to convert 10 N into kgf, read the figure in the right kgf column adjacent to the 10 in the center column in the 1st block. This means that 10 N is 1.01997 kgf. To convert 10 kgf into N, read the figure in the left N column of the same row, which indicates that the answer is 98.066 N.

1 N=0.1019716 kgf  
1 kgf=9.80665 N

N		kgf	N		kgf	N		kgf
9.8066	<b>1</b>	0.1020	333.43	<b>34</b>	3.4670	657.05	<b>67</b>	6.8321
19.613	<b>2</b>	0.2039	343.23	<b>35</b>	3.5690	666.85	<b>68</b>	6.9341
29.420	<b>3</b>	0.3059	353.04	<b>36</b>	3.6710	676.66	<b>69</b>	7.0360
39.227	<b>4</b>	0.4079	362.85	<b>37</b>	3.7729	686.47	<b>70</b>	7.1380
49.033	<b>5</b>	0.5099	372.65	<b>38</b>	3.8749	696.27	<b>71</b>	7.2400
58.840	<b>6</b>	0.6118	382.46	<b>39</b>	3.9769	706.08	<b>72</b>	7.3420
68.647	<b>7</b>	0.7138	392.27	<b>40</b>	4.0789	715.89	<b>73</b>	7.4439
78.453	<b>8</b>	0.8158	402.07	<b>41</b>	4.1808	725.69	<b>74</b>	7.5459
88.260	<b>9</b>	0.9177	411.88	<b>42</b>	4.2828	735.50	<b>75</b>	7.6479
98.066	<b>10</b>	1.0197	421.69	<b>43</b>	4.3848	745.31	<b>76</b>	7.7498
107.87	<b>11</b>	1.1217	431.49	<b>44</b>	4.4868	755.11	<b>77</b>	7.8518
117.68	<b>12</b>	1.2237	441.30	<b>45</b>	4.5887	764.92	<b>78</b>	7.9538
127.49	<b>13</b>	1.3256	451.11	<b>46</b>	4.6907	774.73	<b>79</b>	8.0558
137.29	<b>14</b>	1.4276	460.91	<b>47</b>	4.7927	784.53	<b>80</b>	8.1577
147.10	<b>15</b>	1.5296	470.72	<b>48</b>	4.8946	794.34	<b>81</b>	8.2597
156.91	<b>16</b>	1.6315	480.53	<b>49</b>	4.9966	804.15	<b>82</b>	8.3617
166.71	<b>17</b>	1.7335	490.33	<b>50</b>	5.0986	813.95	<b>83</b>	8.4636
176.52	<b>18</b>	1.8355	500.14	<b>51</b>	5.2006	823.76	<b>84</b>	8.5656
186.33	<b>19</b>	1.9375	509.95	<b>52</b>	5.3025	833.57	<b>85</b>	8.6676
196.13	<b>20</b>	2.0394	519.75	<b>53</b>	5.4045	843.37	<b>86</b>	8.7696
205.94	<b>21</b>	2.1414	529.56	<b>54</b>	5.5065	853.18	<b>87</b>	8.8715
215.75	<b>22</b>	2.2434	539.37	<b>55</b>	5.6084	862.99	<b>88</b>	8.9735
225.55	<b>23</b>	2.3453	549.17	<b>56</b>	5.7104	872.79	<b>89</b>	9.0755
235.36	<b>24</b>	2.4473	558.98	<b>57</b>	5.8124	882.60	<b>90</b>	9.1774
245.17	<b>25</b>	2.5493	568.79	<b>58</b>	5.9144	892.41	<b>91</b>	9.2794
254.97	<b>26</b>	2.6513	578.59	<b>59</b>	6.0163	902.21	<b>92</b>	9.3814
264.78	<b>27</b>	2.7532	588.40	<b>60</b>	6.1183	912.02	<b>93</b>	9.4834
274.59	<b>28</b>	2.8552	598.21	<b>61</b>	6.2203	921.83	<b>94</b>	9.5853
284.39	<b>29</b>	2.9572	608.01	<b>62</b>	6.3222	931.63	<b>95</b>	9.6873
294.20	<b>30</b>	3.0591	617.82	<b>63</b>	6.4242	941.44	<b>96</b>	9.7893
304.01	<b>31</b>	3.1611	627.63	<b>64</b>	6.5262	951.25	<b>97</b>	9.8912
313.81	<b>32</b>	3.2631	637.43	<b>65</b>	6.6282	961.05	<b>98</b>	9.9932
323.62	<b>33</b>	3.3651	647.24	<b>66</b>	6.7301	970.86	<b>99</b>	10.095

Appendix Table 3 kg-lb Conversion Table

How to use this table

For example, to convert 10 kg into lb, read the figure in the right lb column adjacent to the 10 in the center column in the 1st block. This means that 10 kg is 22.046 lb. To convert 10 lb into kg, read the figure in the left kg column of the same row, which indicates that the answer is 4.536 kg.

1 kg=2.2046226 lb  
1 lb=0.45359237 kg

kg		lb	kg		lb	kg		lb
0.454	<b>1</b>	2.205	15.422	<b>34</b>	74.957	30.391	<b>67</b>	147.71
0.907	<b>2</b>	4.409	15.876	<b>35</b>	77.162	30.844	<b>68</b>	149.91
1.361	<b>3</b>	6.614	16.329	<b>36</b>	79.366	31.298	<b>69</b>	152.12
1.814	<b>4</b>	8.818	16.783	<b>37</b>	81.571	31.751	<b>70</b>	154.32
2.268	<b>5</b>	11.023	17.237	<b>38</b>	83.776	32.205	<b>71</b>	156.53
2.722	<b>6</b>	13.228	17.690	<b>39</b>	85.980	32.659	<b>72</b>	158.73
3.175	<b>7</b>	15.432	18.144	<b>40</b>	88.185	33.112	<b>73</b>	160.94
3.629	<b>8</b>	17.637	18.597	<b>41</b>	90.390	33.566	<b>74</b>	163.14
4.082	<b>9</b>	19.842	19.051	<b>42</b>	92.594	34.019	<b>75</b>	165.35
4.536	<b>10</b>	22.046	19.504	<b>43</b>	94.799	34.473	<b>76</b>	167.55
4.990	<b>11</b>	24.251	19.958	<b>44</b>	97.003	34.927	<b>77</b>	169.76
5.443	<b>12</b>	26.455	20.412	<b>45</b>	99.208	35.380	<b>78</b>	171.96
5.897	<b>13</b>	28.660	20.865	<b>46</b>	101.41	35.834	<b>79</b>	174.17
6.350	<b>14</b>	30.865	21.319	<b>47</b>	103.62	36.287	<b>80</b>	176.37
6.804	<b>15</b>	33.069	21.772	<b>48</b>	105.82	36.741	<b>81</b>	178.57
7.257	<b>16</b>	35.274	22.226	<b>49</b>	108.03	37.195	<b>82</b>	180.78
7.711	<b>17</b>	37.479	22.680	<b>50</b>	110.23	37.648	<b>83</b>	182.98
8.165	<b>18</b>	39.683	23.133	<b>51</b>	112.44	38.102	<b>84</b>	185.19
8.618	<b>19</b>	41.888	23.587	<b>52</b>	114.64	38.555	<b>85</b>	187.39
9.072	<b>20</b>	44.092	24.040	<b>53</b>	116.84	39.009	<b>86</b>	189.60
9.525	<b>21</b>	46.297	24.494	<b>54</b>	119.05	39.463	<b>87</b>	191.80
9.979	<b>22</b>	48.502	24.948	<b>55</b>	121.25	39.916	<b>88</b>	194.01
10.433	<b>23</b>	50.706	25.401	<b>56</b>	123.46	40.370	<b>89</b>	196.21
10.886	<b>24</b>	52.911	25.855	<b>57</b>	125.66	40.823	<b>90</b>	198.42
11.340	<b>25</b>	55.116	26.308	<b>58</b>	127.87	41.277	<b>91</b>	200.62
11.793	<b>26</b>	57.320	26.762	<b>59</b>	130.07	41.730	<b>92</b>	202.83
12.247	<b>27</b>	59.525	27.216	<b>60</b>	132.28	42.184	<b>93</b>	205.03
12.701	<b>28</b>	61.729	27.669	<b>61</b>	134.48	42.638	<b>94</b>	207.23
13.154	<b>29</b>	63.934	28.123	<b>62</b>	136.69	43.091	<b>95</b>	209.44
13.608	<b>30</b>	66.139	28.576	<b>63</b>	138.89	43.545	<b>96</b>	211.64
14.061	<b>31</b>	68.343	29.030	<b>64</b>	141.10	43.998	<b>97</b>	213.85
14.515	<b>32</b>	70.548	29.484	<b>65</b>	143.30	44.452	<b>98</b>	216.05
14.969	<b>33</b>	72.753	29.937	<b>66</b>	145.51	44.906	<b>99</b>	218.26

Appendix Table 4 °C - °F Conversion Table

How to use this table

For example, to convert 38 °C into °F, read the figure in the right °F column adjacent to the 38 in the center column in the 2nd block. This means that 38 °C is 100.4 °F. To convert 38 °F into °C, read the figure in the left °C column of the same row, which indicates that the answer is 3.3 °C.

$$C = \frac{5}{9}(F - 32)$$

$$F = 32 + \frac{9}{5}C$$

°C		°F	°C		°F	°C		°F	°C		°F
-73.3	-100	-148.0	0.0	32	89.6	21.7	71	159.8	43.3	110	230
-62.2	80	-112.0	0.6	33	91.4	22.2	72	161.6	46.1	115	239
-51.1	60	-76.0	1.1	34	93.2	22.8	73	163.4	48.9	120	248
-40.0	40	-40.0	1.7	35	95.0	23.3	74	165.2	51.7	125	257
-34.4	30	-22.0	2.2	36	96.8	23.9	75	167.0	54.4	130	266
-28.9	20	-4.0	2.8	37	98.6	24.4	76	168.8	57.2	135	275
-23.3	10	14.0	3.3	38	100.4	25.0	77	170.6	60.0	140	284
-17.8	0	32.0	3.9	39	102.2	25.6	78	172.4	65.6	150	302
-17.2	1	33.8	4.4	40	104.0	26.1	79	174.2	71.1	160	320
-16.7	2	35.6	5.0	41	105.8	26.7	80	176.0	76.7	170	338
-16.1	3	37.4	5.6	42	107.6	27.2	81	177.8	82.2	180	356
-15.6	4	39.2	6.1	43	109.4	27.8	82	179.6	87.8	190	374
-15.0	5	41.0	6.7	44	111.2	28.3	83	181.4	93.3	200	392
-14.4	6	42.8	7.2	45	113.0	28.9	84	183.2	98.9	210	410
-13.9	7	44.6	7.8	46	114.8	29.4	85	185.0	104.4	220	428
-13.3	8	46.4	8.3	47	116.6	30.0	86	186.8	110.0	230	446
-12.8	9	48.2	8.9	48	118.4	30.6	87	188.6	115.6	240	464
-12.2	10	50.0	9.4	49	120.2	31.1	88	190.4	121.1	250	482
-11.7	11	51.8	10.0	50	122.0	31.7	89	192.2	148.9	300	572
-11.1	12	53.6	10.6	51	123.8	32.2	90	194.0	176.7	350	662
-10.6	13	55.4	11.1	52	125.6	32.8	91	195.8	204	400	752
-10.0	14	57.2	11.7	53	127.4	33.3	92	197.6	232	450	842
-9.4	15	59.0	12.2	54	129.2	33.9	93	199.4	260	500	932
-8.9	16	60.8	12.8	55	131.0	34.4	94	201.2	288	550	1022
-8.3	17	62.6	13.3	56	132.8	35.0	95	203.0	316	600	1112
-7.8	18	64.4	13.9	57	134.6	35.6	96	204.8	343	650	1202
-7.2	19	66.2	14.4	58	136.4	36.1	97	206.6	371	700	1292
-6.7	20	68.0	15.0	59	138.2	36.7	98	208.4	399	750	1382
-6.1	21	69.8	15.6	60	140.0	37.2	99	210.2	427	800	1472
-5.6	22	71.6	16.1	61	141.8	37.8	100	212.0	454	850	1562
-5.0	23	73.4	16.7	62	143.6	38.3	101	213.8	482	900	1652
-4.4	24	75.2	17.2	63	145.4	38.9	102	215.6	510	950	1742
-3.9	25	77.0	17.8	64	147.2	39.4	103	217.4	538	1 000	1832
-3.3	26	78.8	18.3	65	149.0	40.0	104	219.2	593	1 100	2012
-2.8	27	80.6	18.9	66	150.8	40.6	105	221.0	649	1 200	2192
-2.2	28	82.4	19.4	67	152.6	41.1	106	222.8	704	1 300	2372
-1.7	29	84.2	20.0	68	154.4	41.7	107	224.6	760	1 400	2552
-1.1	30	86.0	20.6	69	156.2	42.2	108	226.4	816	1 500	2732
-0.6	31	87.8	21.1	70	158.0	42.8	109	228.2	871	1 600	2912

Appendix Table 5 Viscosity Conversion Table

Kinematic Viscosity mm <sup>2</sup> /s	Saybolt Universal SUS (sec)		No.1 Type Redwood R (sec)		Engler E (degree)	Kinematic Viscosity mm <sup>2</sup> /s	Saybolt Universal SUS (sec)		No.1 Type Redwood R (sec)		Engler E (degree)
	100 °F	210 °F	50 °C	100 °C			100 °F	210 °F	50 °C	100 °C	
2	32.6	32.8	30.8	31.2	1.14	35	163	164	144	147	4.70
3	36.0	36.3	33.3	33.7	1.22	36	168	170	148	151	4.83
4	39.1	39.4	35.9	36.5	1.31	37	172	173	153	155	4.96
5	42.3	42.6	38.5	39.1	1.40	38	177	178	156	159	5.08
6	45.5	45.8	41.1	41.7	1.48	39	181	183	160	164	5.21
7	48.7	49.0	43.7	44.3	1.56	40	186	187	164	168	5.34
8	52.0	52.4	46.3	47.0	1.65	41	190	192	168	172	5.47
9	55.4	55.8	49.1	50.0	1.75	42	195	196	172	176	5.59
10	58.8	59.2	52.1	52.9	1.84	43	199	201	176	180	5.72
11	62.3	62.7	55.1	56.0	1.93	44	204	205	180	185	5.85
12	65.9	66.4	58.2	59.1	2.02	45	208	210	184	189	5.98
13	69.6	70.1	61.4	62.3	2.12	46	213	215	188	193	6.11
14	73.4	73.9	64.7	65.6	2.22	47	218	219	193	197	6.24
15	77.2	77.7	68.0	69.1	2.32	48	222	224	197	202	6.37
16	81.1	81.7	71.5	72.6	2.43	49	227	228	201	206	6.50
17	85.1	85.7	75.0	76.1	2.54	50	231	233	205	210	6.63
18	89.2	89.8	78.6	79.7	2.64	55	254	256	225	231	7.24
19	93.3	94.0	82.1	83.6	2.76	60	277	279	245	252	7.90
20	97.5	98.2	85.8	87.4	2.87	65	300	302	266	273	8.55
21	102	102	89.5	91.3	2.98	70	323	326	286	294	9.21
22	106	107	93.3	95.1	3.10	75	346	349	306	315	9.89
23	110	111	97.1	98.9	3.22	80	371	373	326	336	10.5
24	115	115	101	103	3.34	85	394	397	347	357	11.2
25	119	120	105	107	3.46	90	417	420	367	378	11.8
26	123	124	109	111	3.58	95	440	443	387	399	12.5
27	128	129	112	115	3.70	100	464	467	408	420	13.2
28	132	133	116	119	3.82	120	556	560	490	504	15.8
29	137	138	120	123	3.95	140	649	653	571	588	18.4
30	141	142	124	127	4.07	160	742	747	653	672	21.1
31	145	146	128	131	4.20	180	834	840	734	757	23.7
32	150	150	132	135	4.32	200	927	933	816	841	26.3
33	154	155	136	139	4.45	250	1 159	1 167	1 020	1 051	32.9
34	159	160	140	143	4.57	300	1 391	1 400	1 224	1 241	39.5

Remarks 1 mm<sup>2</sup>/s=1 cSt





Appendix Table 8 Values of Standard Tolerance Grades IT

Basic Size (mm)		Standard											Grades								Basic Size (mm)	
		IT1	IT2	IT3	IT4	IT5	IT6	IT7	IT8	IT9	IT10	IT11	IT12	IT13	IT14	IT15	IT16	IT17	IT18			
over	incl.	Tolerances (μm)											Tolerances (mm)								over	incl.
—	3	0.8	1.2	2	3	4	6	10	14	25	40	60	0.10	0.14	0.25	0.40	0.60	1.00	1.40	—	3	
3	6	1	1.5	2.5	4	5	8	12	18	30	48	75	0.12	0.18	0.30	0.48	0.75	1.20	1.80	3	6	
6	10	1	1.5	2.5	4	6	9	15	22	36	58	90	0.15	0.22	0.36	0.58	0.90	1.50	2.20	6	10	
10	18	1.2	2	3	5	8	11	18	27	43	70	110	0.18	0.27	0.43	0.70	1.10	1.80	2.70	10	18	
18	30	1.5	2.5	4	6	9	13	21	33	52	84	130	0.21	0.33	0.52	0.84	1.30	2.10	3.30	18	30	
30	50	1.5	2.5	4	7	11	16	25	39	62	100	160	0.25	0.39	0.62	1.00	1.60	2.50	3.90	30	50	
50	80	2	3	5	8	13	19	30	46	74	120	190	0.30	0.46	0.74	1.20	1.90	3.00	4.60	50	80	
80	120	2.5	4	6	10	15	22	35	54	87	140	220	0.35	0.54	0.87	1.40	2.20	3.50	5.40	80	120	
120	180	3.5	5	8	12	18	25	40	63	100	160	250	0.40	0.63	1.00	1.60	2.50	4.00	6.30	120	180	
180	250	4.5	7	10	14	20	29	46	72	115	185	290	0.46	0.72	1.15	1.85	2.90	4.60	7.20	180	250	
250	315	6	8	12	16	23	32	52	81	130	210	320	0.52	0.81	1.30	2.10	3.20	5.20	8.10	250	315	
315	400	7	9	13	18	25	36	57	89	140	230	360	0.57	0.89	1.40	2.30	3.60	5.70	8.90	315	400	
400	500	8	10	15	20	27	40	63	97	155	250	400	0.63	0.97	1.55	2.50	4.00	6.30	9.70	400	500	
500	630	9	11	16	22	32	44	70	110	175	280	440	0.70	1.10	1.75	2.80	4.40	7.00	11.00	500	630	
630	800	10	13	18	25	36	50	80	125	200	320	500	0.80	1.25	2.00	3.20	5.00	8.00	12.50	630	800	
800	1 000	11	15	21	28	40	56	90	140	230	360	560	0.90	1.40	2.30	3.60	5.60	9.00	14.00	800	1 000	
1 000	1 250	13	18	24	33	47	66	105	165	260	420	660	1.05	1.65	2.60	4.20	6.60	10.50	16.50	1 000	1 250	
1 250	1 600	15	21	29	39	55	78	125	195	310	500	780	1.25	1.95	3.10	5.00	7.80	12.50	19.50	1 250	1 600	
1 600	2 000	18	25	35	46	65	92	150	230	370	600	920	1.50	2.30	3.70	6.00	9.20	15.00	23.00	1 600	2 000	
2 000	2 500	22	30	41	55	78	110	175	280	440	700	1 100	1.75	2.80	4.40	7.00	11.00	17.50	28.00	2 000	2 500	
2 500	3 150	26	36	50	68	96	135	210	330	540	860	1 350	2.10	3.30	5.40	8.60	13.50	21.00	33.00	2 500	3 150	

Remarks 1. Standard tolerance grades IT14 to IT18 shall not be used for basic sizes less than or equal to 1 mm.  
 2. Values for standard tolerance grades IT1 to IT5 for basic sizes over 500 mm are included for experimental use.

Appendix Table 9 Physical and Mechanical Properties of Materials

Materials	Specific Gravity	Coefficient of Linear Expansion (0 to 100 °C) (K <sup>-1</sup> )	Hardness (Brinell)	Modulus of Direct Elasticity (MPa) {kgf/mm <sup>2</sup> }	Tensile Strength (MPa) {kgf/mm <sup>2</sup> }	Yield Point (MPa) {kgf/mm <sup>2</sup> }	Elongation (%)
Bearing Steel (hardened)	7.83	12.5 × 10 <sup>-6</sup>	650 to 740	208 000 {21 200}	1 570 to 1 960 {160 to 200}	—	—
Martensitic Stainless Steel SUS 440C	7.68	10.1 × 10 <sup>-6</sup>	580	200 000 {20 400}	1 960 {200}	1 860 {190}	—
Mild Steel (C=0.12 to 0.20 %)	7.86	11.6 × 10 <sup>-6</sup>	100 to 130	206 000 {21 000}	373 to 471 {38 to 48}	216 to 294 {22 to 30}	24 to 36
Hard Steel (C=0.3 to 0.5 %)	7.84	11.3 × 10 <sup>-6</sup>	160 to 200	206 000 {21 000}	539 to 686 {55 to 70}	333 to 451 {34 to 46}	14 to 26
Austenitic Stainless Steel SUS 304	8.03	16.3 × 10 <sup>-6</sup>	150	193 000 {19 700}	588 {60}	245 {25}	60
Cast Iron	Gray Iron FC200	7.3	223	98 100 {10 000}	More than 200 {20}	—	—
	Spheroidal graphite Iron FCD400	7.0	Less than 201		More than 400 {41}	—	More than 12
Aluminum	2.69	23.7 × 10 <sup>-6</sup>	15 to 26	70 600 {7 200}	78 {8}	34 {3.5}	35
Zinc	7.14	31 × 10 <sup>-6</sup>	30 to 60	92 200 {9 400}	147 {15}	—	30 to 40
Copper	8.93	16.2 × 10 <sup>-6</sup>	50	123 000 {12 500}	196 {20}	69 {7}	15 to 20
Brass	(Annealed)	8.5	45	103 000 {10 500}	294 to 343 {30 to 35}	—	65 to 75
	(Machined)		85 to 130		363 to 539 {37 to 55}		15 to 50

Remarks The hardness of hardened bearing steel and martensitic stainless steel is usually expressed using the Rockwell C Scale, but for comparison, it is converted into Brinell hardness.

### Bearing Conversion Tables

	Page
<b>Conversion Table 1 Deep groove ball bearings open type</b> (Metric series) .....	66
<b>Conversion Table 2 Deep groove ball bearings shielded type</b> (Metric series) .....	67
<b>Conversion Table 3 Deep groove ball bearings with flanged outer ring open type</b> (Metric series) .....	68
<b>Conversion Table 4 Deep groove ball bearings with flanged outer ring shielded type</b> (Metric series) .....	69
<b>Conversion Table 5 Deep groove ball bearings open type</b> (Inch series) .....	70
<b>Conversion Table 6 Deep groove ball bearings shielded type</b> (Inch series) .....	70
<b>Conversion Table 7 Deep groove ball bearings with flanged outer ring open type</b> (Inch series) .....	71
<b>Conversion Table 8 Deep groove ball bearings with flanged outer ring shielded type</b> (Inch series) .....	71
<b>Conversion Table 9 Deep groove ball bearings with extended inner ring open type</b> (Inch series) .....	72
<b>Conversion Table 10 Deep groove ball bearings with extended inner ring shielded type</b> (Inch series) .....	72
<b>Conversion Table 11 Deep groove ball bearings with extended inner ring, flanged open type</b> (Inch series) .....	73
<b>Conversion Table 12 Deep groove ball bearings with extended inner ring, flanged shielded type</b> (Inch series) .....	73
<b>Conversion Table 13 Ball bearings for synchros</b> (Inch series) .....	74



**Conversion Table 1**  
**Deep groove ball bearings**  
**Open type (Metric series)**

Bore diameter d		NSK	ADR	FAG	GRW	RMB	BARDEN	MPB	NMB	NTN
mm	inch									
1	0.0394	681 MR31 691	AX1 — —	— — —	681 — 691	UL103 — —	— — —	— — —	L-310 L-310W51 R-410	681 — 691
1.2	0.0472	MR41X	—	—	—	—	—	—	R-412	BC1.2-4
1.5	0.0591	681X 691X 601X	AX1.5 619/1.5 —	— MR69/1.5 —	68/1.5 69/1.5 —	UL154 R1550 —	— 19M1-5Y1 —	— EL1.5C —	R-415 R-515 R-615	68/1.5 69/1.5 60/1.5
2	0.0787	682 MR52B 692  MR62 MR72 602	BX2 — AX2 — —	MR682 — MR619/2 — —	682 — 692 — —	UL205 — R2060 — —	— — 19M2Y1 — —	— UL20C — EL2C —	L-520 L-520W02 R-620  R-620W52 R-720Y52 R-720	682 BC2-5 692  BC2-6 BC2-7 602
2.5	0.0984	682X 692X MR82X 602X	AX2.5 — X2.5 — 60/2.5	— — — MR60/2.5	68/2.5 69/2.5 — 60/2.5	UL256 — — R2580	— 18M2-5 19M2-5Y1 — —	— — — —	L-625 R-725 R-825Y52 R-825	68/2.5 69/2.5 BC2.5-8 60/2.5
3	0.1181	MR63 683A MR63  693 MR93 603  623 633	617/3 — AX3 — 619/3 — — 623 —	— — MR618/3 — — — MR623 —	— 683 693/003 — 693 — 623 —	— UL307 — — — — R3100 —	— — — — — 2M3Y1 —	— UL30C — — — EL-3R —	L-630 L-730 R-830Y52  R-830 R-930Y52 R-930  R-1030 —	673 683 BC3-8  693 BC3-9 603  623 633
4	0.1575	MR74 MR84 684A  MR104B 694 604  624 634	617/4 — AX4 — X4 AY4 604  624 634	— — MR618/4 — — — MR624 MR634	— 684 — 694 604  624 634	— UL409 — — — — R4130 R4160	— — — — — 2M4 34	— UL40C — — — — EL4R —	L-740 L-840 L-940  L-1040 R-1140 R-1240  R-1340 R-1640	674 BC4-8 684  BC4-10 694 604  624 634
5	0.1969	MR85 MR95 MR105  685 695 605  625 635	617/5 — — — X5 AY5 —  625 635	— — — — MR618/5 — — MR625 MR635	— — — — 685 695 605  625 635	— — — — UL511 — — R5160 R5190	— — — — — 34-5 35	— — — — UL50C — — EL5R —	L-850 L-950 L-1050  L-1150 R-1350 R-1450  R-1650 R-1950	675 BC5-9 BC5-10  685 695 605  625 635
6	0.2362	MR106 MR126 686A  696 606 626 636	617/6 — X6 AX6  AY6 — 626 —	— — MR618/6 — — — MR626 —	— — 686 — 696 — 626 —	— — UL613 — — — U6190 36	— — — — — — 36	— UL60C — — — EL6R —	L-1060 L-1260 L-1360  R-1560 R-1760 R-1960  — —	676 BC6-12 686  696 606 626 636
7	0.2756	MR117 MR137 687  697 607 627 637	617/7 — AX7  AY7 607 627 637	— — 618/7 — — MR607 MR627 —	— — 687 — 697 607 627 —	— — UL714 — — — R7220 37	— — — — — — 37	— UL70C — — EL7R —	L-1170 L-1370 L-1470  — R-1970 R-2270  — —	677 BC7-13 687  697 607 627 637
8	0.3150	MR128 MR148 688A  698 608 628 638	617/8 — X8  AY8 608 — —	— — MR618/8 — — MR608 — —	— — 688 — 698 608 — —	— — UL816 — — — R8220 —	— — — — 19M8 38 — —	— — — — EL8R —	L-1280 L-1480 L-1680  R-1980 R-2280  — —	678 BC8-14 688  698 608 628 638
9	0.3543	689 699 609 629 639	X9 AY9 609 629 —	— — 609 MR629 —	689 699 609 629 —	UL917 — 609 — —	— — 19M9 39 —	— — — — —	L-1790 L-2090  — —	689 699 609 629 639
In case of stainless steel		h S	W	S	S	X	S	S	SS	F

**Conversion Table 2**  
**Deep groove ball bearings**  
**Shielded type (Metric series)**

Bore diameter d		NSK	ADR	FAG	GRW	RMB	BARDEN	MPB	NMB	NTN	
mm	inch										
1.5	0.0591	681XZZ 691XZZ 601XZZS	AX1.5ZZ X1.5ZZ —	— — —	68/1.5-2Z 69/1.5-2Z —	ULZ154 — —	— — —	— — —	UL15CHH — —	L-415ZZ R-515ZZ R-615ZZ	W68/1.5ZZA W69/1.5ZZA W60/1.5ZZA
2	0.0787	682ZZ MR52BZZ 692ZZ  MR62ZZ MR72ZZ 602ZZ	BX2ZZ — AX2ZZ — — —	— — — — — —	682-2Z — — — — —	ULZ205 — — — — —	38M2SS — — — — —	— — — — — —	UL20CHH — — — — —	L-520ZZ L-520ZZW52 R-620ZZ  R-620ZZY52 R-720ZZY03 R-720ZZ	W682ZZA WBC2-5ZZA W692ZZA  — WBC2-7ZZA W602ZZA
2.5	0.0984	682XZZ 692XZZ 602XZZ	AX2.5ZZ — —	— — —	68/2.5-2Z 69/2.5-2Z —	ULZ256 — —	38M2-5SS — —	— — —	— — —	L-625ZZ R-725ZZ R-825ZZ	W68/2.5ZZA W69/2.5ZZA W60/2.5ZZA
3	0.1181	MR63ZZ 683AZZ 693ZZ  MR93ZZ 623ZZ 633ZZ	— AX3ZZ — — 623ZZ —	— — — — 623.27 —	— 683-2Z 693-2Z — 623-2Z —	— ULZ307 — — RF310 —	— 38M3SS — — 2M3SSY1 —	— — — — EL3RHH —	— UL30CHH — — — —	L-630ZZ L-730ZZ R-830ZZ  R-930ZZY04 R-1030ZZ —	WA673ZZA W683ZZA W693ZZA  WBC3-9ZZA 623ZZ 633ZZ
4	0.1575	MR74ZZ MR84ZZ 684AZZ  MR104BZZ 694ZZ 604ZZ  624ZZ 634ZZ1	— — 638/4ZZ — X4ZZ AY4ZZ 604ZZ  624ZZ 634ZZ	— — — — — — — 624.2Z MR634.2Z	— 684-2Z — 694-2Z 604-2Z  624-2Z 634-2Z	— ULZ409 — — RF413 RV416	— 38M455 — — 2M4SS 34SS	— — — — EL4RHH 34RHH	— UL40CHH — — — —	L-740XZZ L-840ZZ L-940ZZ  L-1040ZZ R-1140ZZ R-1240ZZ  R-1340ZZ R-1640ZZ	WA674ZZA WBC4-8ZZA W684ZZA  WBC4-10ZZA 694ZZ 604ZZ  624ZZ 634ZZ
5	0.1969	MR85ZZ MR95ZZ1 MR105ZZ  685ZZ 695ZZ 605ZZ  625ZZ1 635ZZ1	— — — — 638/5ZZ AY5ZZ —  625ZZ 635ZZ	— — — — — — — 625.2Z MR635.2Z	— 685-2Z 695-2Z 605-2Z  625-2Z 635-2Z	— ULZ511 — — RV516 RV519	— — — — 34-5SS 35SS	— — — — EL5RHH —	— UL50CHH — — — —	L-850ZZ L-950XZZ L-1050ZZ  L-1150ZZ R-1350ZZ R-1450ZZ  R-1650ZZ R-1950ZZ	WA675ZZA WBC5-9ZZA WBC5-10ZZA  W685ZZ 695ZZ 605ZZ  625ZZ 635ZZ
6	0.2362	MR106ZZ1 MR126ZZ 686AZZ  696ZZ1 606ZZ 626ZZ1 636ZZ	— — X6ZZ 628/6ZZ  ZY6ZZ — 626ZZ —	— — — — — — — —	— 686-2Z — 696-2Z 606-2Z  626-2Z —	— ULZ613 — — RV619 36SS	— — — — 36SS —	— — — — EL6RHH —	— UL60CHH — — — —	L-1060ZZ L-1260ZZ L-1360ZZ  R-1560ZZ R-1760ZZ R-1960ZZ  — —	WA676ZZA WBC6-12ZZA W686ZZ  696ZZ 606ZZ 626ZZ 636ZZ
7	0.2756	MR117ZZ MR137ZZ 687ZZ1  697ZZ1 607ZZ1 627ZZ 637ZZ	— — AX7ZZ  AY7ZZ 607ZZ 627ZZ 637ZZ	— — — — — — — 607.2Z MR627.2Z	— 687-2Z — 697-2Z 607-2Z  627-2Z —	— ULZ714 — — RV722 37SS	— — — — 37SS —	— — — — EL7RHH —	— UL70CH — — — —	L-1170ZZ L-1370ZZ L-1470ZZ  — R-1970ZZ R-2270ZZ  — —	WA677ZZA WBC7-13ZZA W687ZZ  697ZZ 607ZZ 627ZZ 637ZZ
8	0.3150	MR128ZZ1 MR148ZZ 688AZZ1  698ZZ 608ZZ 628ZZ 638ZZ	— — X8ZZ  AY8ZZ 608ZZ 628ZZ 638ZZ	— — — — — — — 609.2Z MR629.2Z	— 688-2Z — 698-2Z 608-2Z  628-2Z —	— ULZ816 — — RV822 38SS	— — — — 19M8SS 38SS	— — — — EL8RHH —	— UL80CH — — — —	L-1280ZZ L-1480ZZ L-1680ZZ  R-1980ZZ R-2280ZZ  — —	W678ZZA WBC8-14ZZ W688ZZ  698ZZ 608ZZ 628ZZ 638ZZ
9	0.3543	689ZZ1 699ZZ1 609ZZ 629ZZ 639ZZ	X9ZZ AY9ZZ 609ZZ 629ZZ —	— — 609.2Z MR629.2Z —	689-2Z 699-2Z 609-2Z 629-2Z —	— ULZ917 — — 39SS —	— — — — 39SS —	— — — — — —	— UL90CH — — — —	L-1790ZZ L-2090ZZ  — —	W689ZZ 699ZZ 609ZZ 629ZZ 639ZZ
In case of stainless steel		h S	W	S	S	X	S	S	SS	F	

**Conversion Table 3**  
**Deep groove ball bearings with flanged outer ring**  
**Open type (Metric series)**

Bore diameter d		NSK	ADR	GRW	RMB	BARDEN	MPB	NMB	NTN
mm	inch								
1	0.0394	F681 F691	—	—	—	—	—	LF-310 RF-410	FL681 FL691
1.2	0.0472	MF41X	—	—	—	—	—	RF-412	FLBC1.2-4
1.5	0.0591	F681X F691X F601X	FAX1.5 F619/1.5	F68/1.5 F69/1.5	ULK154	— F19M1-5Y1	—	LF-415 RF-515 RF-615	FL68/1.5 FL69/1.5 EL60/1.5
2	0.0787	F682 MF52B F692	FBX2 FAX2	F682 F692	ULK205 RK2060	F682 F692	UL20FC	LF-520 RF-620	FL682 FL692
		MF62 MF72 F602	—	—	—	—	—	RF-620W52 RF-720Y52 RF-720	FLBC2-6 FL602
2.5	0.0984	F682X F692X MF82X F602X	FAX2.5 FX2.5	F68/2.5 F69/2.5	ULK256 — RK2580	F68/2.5 F19M2-5Y1	—	LF-625 RF-725 RF-825Y52 RF-825	FL68/2.5 FL69/2.5 FLBC2.5-8 FL60/2.5
3	0.1181	MF63 F683A MF83	— FAX3	— F683	— ULK307	— F683	— UL30FC	LF-630 LF-730 RF-830Y52	FL673 FL683 FLBC3-8
		F693 MF93 F603	— FX3	— F693	— —	— F693	— —	RF-830 RF-930Y52 RF-930	FL693 FLBC3-9 FL603
		F623	F623	F623	RK3100	F623	—	RF-1030	FL623
4	0.1575	MF74 MF84 F684A	— FAX4	— F684	— ULK409	— F684	— UL40FC	LF-740 LF-840 LF-940	FL674 FLBC4-8 FL684
		MF104B F694 F604	— —	— F694	— —	— F694	— —	LF-1040 RF-1140 RF-1240	FLBC4-10 FL694 FL604
		F624 F634	F624	F624 F634	— —	F624 F634	— —	RF-1340 RF-1640	FL624
5	0.1969	MF85 MF95 MF105	— — —	— — —	— — —	— — —	— — —	LF-850 LF-950 LF-1050	FL675 FLBC5-9 FLBC5-10
		F685 F695 F605	FX5	F685 F695 F605	ULK511	F685 F695	UL50FC	LF-1150 RF-1350 RF-1450	FL685 FL695 FL605
		F625 F635	—	F625 F635	—	F625 F635	—	RF-1650 RF-1950	FL625
6	0.2362	MF106 MF126 F686A	— FAX6	— F686	— —	— F686	— UL60FC	LF-1060 LF-1260 LF-1360	FL676 FLBC6-12 FL686
		F696 F606 F626	— —	F696 F626	— —	F696 F626	— —	RF-1560 RF-1760 RF-1960	FL696 FL606 FL626
7	0.2756	MF117 MF137 F687	— FAX7	— F687	— ULK714	— F687	— UL70FC	LF-1170 LF-1370 LF-1470	FL677 FLBC7-13 FL687
		F697 F607 F627	— F607	F697 F607	— —	F697 F607	— —	— RF-2270	FL697
8	0.3150	MF128 MF148 F688A	— FX8	— F688	— ULK816	— F688	— —	LF-1280 LF-1480 LF-1680	FL678 FLBC8-14 FL688
		F698 F608	— F608	F698 F608	— —	F698	— —	RF-1980 RF-2280	FL698 FL608
9	0.3543	F689 F699	FX9	F689	—	—	—	LF-1790	FL689
In case of stainless steel		h S	W	S	X	S	S	SS	F

**Conversion Table 4**  
**Deep groove ball bearings with flanged outer ring**  
**Shielded type (Metric series)**

Bore diameter d		NSK	ADR	GRW	RMB	BARDEN	MPB	NMB	NTN
mm	inch								
1.5	0.591	F691XZZ F601XZZ	FX1.5ZZ	F69/1.5-2Z	—	—	—	RF-515ZZ RF-615ZZ	FLW69/1.5ZZA FLW60/1.5ZZA
2	0.0787	F682ZZ MF52BZZ F692ZZ MF72ZZ F602ZZ	FBX2ZZ FAX2ZZ	F682-2Z	ULKZ205	F682SS F692SS	UL20FCHH	LF-520ZZ RF-620ZZ RF-720ZZY03 RF-720ZZ	FLW682ZZA — FLW692ZZA FLWBC2-7ZZA FLW602ZZA
2.5	0.0984	F682XZZ F692XZZ F602XZZ	FAX2.5ZZ FX2.5ZZ	F68/2.5-2Z F69/2.5-2Z	ULKZ256	F68/2.5SS F69/2.5SS	—	LF-625ZZ RF-725ZZ RF-825ZZ	FLW68/2.5ZZA FLW69/2.5ZZA FLW60/2.5ZZA
3	0.1181	MF63ZZ F683AZZ F693ZZ	— FAX3ZZ FX3ZZ	— F683-2Z F693-2Z	— ULKZ307 RKF308	— F683SS	UL30FCHH	FL-630ZZ LF-730ZZ RF-830ZZ	FLWA673ZZA FLW683ZZA FLW693ZZA
		MF93ZZ F623ZZ	— F623ZZ	— F623-2Z	— RKF310	— F623SS	—	RF-930ZZY04 RF-1030ZZ	FLWBC3-9ZZA FL623ZZA
4	0.1575	MF74ZZ MF84ZZ F684AZZ	— — F638/4ZZ	— — F684-2Z	— — ULKZ409	— — F684SS	UL40FCHH	LF-740ZZ LF-840ZZ LF-940ZZ	FLWA674ZZA FLWBC4-8ZZA FLW684ZZA
		MF104BZZ F694ZZ F604ZZ	— — —	— F694-2Z	— —	— F694SS	—	LF-1040ZZ RF-1140ZZ RF-1240ZZ	FLAWBC4-10ZZA FL694ZZA FL604ZZ
		F624ZZ F634ZZ1	F624ZZ	F624-2Z F634-2Z	— —	— F624SS F634SS	—	RF-1340ZZ RF-1640ZZ	FL624ZZ FL634ZZ
5	0.1969	MF85ZZ MF95ZZ1 MF105ZZ	— — —	— — —	— — —	— — —	— — —	LF-850ZZ LF-950ZZ LF-1050ZZ	FLWA675ZZA FLWBC5-9ZZA FLAWBC5-10ZZA
		F685ZZ F695ZZ F605ZZ	F638/5ZZ	F685-2Z F695-2Z F605-2Z	ULKZ511	F685SS F695SS	UL50FCHH	LF-1150ZZ RF-1350ZZ RF-1450ZZ	FLW685ZZA FL695ZZ FL605ZZ
		F625ZZ1 F635ZZ1	—	F625-2Z F635-2Z	—	— F625SS F635SS	—	RF-1650ZZ RF-1950ZZ	FL625ZZ FL635ZZ
6	0.2362	MF106ZZ1 MF126ZZ F686AZZ	— F628/6ZZ	— F686-2Z	— ULKZ613	— F686SS	UL60FCHH	LF-1060ZZ UF-1260ZZ LF-1360ZZ	FLWA676ZZA FLWBC6-12ZZA FLW686ZZA
		F696ZZ1 F606ZZ F626ZZ1	— — —	F696-2Z — F626-2Z	— — —	— F696SS F626SS	—	RF-1560ZZ RF-1760ZZ	FL696ZZ FL606ZZ FL626ZZ
7	0.2756	MF117ZZ MF137ZZ F687ZZ1	— FAX7ZZ	— F687-2Z	— ULKZ714	— F687SS	UL70FCHH	LF-1170ZZ LF-1370ZZ LF-1470ZZ	FLWA677ZZA FLWBC7-13ZZA FLW687ZZA
		F697ZZ1 F607ZZ1 F627ZZ	— F607ZZ	F697-2Z F607-2Z F627-2Z	— — —	— F697SS F607SS F627SS	—	— RF-2270ZZ	FL697ZZ FL607ZZ FL627ZZ
8	0.3150	MF128ZZ1 MF148ZZ F688AZZ1	— — —	— — —	— — —	— F688SS	—	LF-1280ZZ UF-1480ZZ UF-1680ZZ	FLWA678ZZA FLWBC8-14ZZA FLW688ZZ
		F698ZZ F608ZZ	— F608ZZ	F698-2Z F608-2Z	— —	— F698SS F608SS	—	— RF-2280ZZ	FL698ZZ FL608ZZ
9	0.3543	F689ZZ1 F699ZZ1	— —	— —	— —	— F689SS	—	LF-1790ZZ	FLW689ZZ FL699ZZ
In case of stainless steel		h S	W	S	X	S	S	SS	F



**Conversion Table 5**  
Deep groove ball bearings  
Open type (Inch series)

Bore diameter d		NSK	ADR	FAG	GRW	RMB	BARDEN	MPB	NMB	NTN
mm	inch									
1.016	0.0400	R09	R09	R0308	1016	UL1304	—	2C	R1-2	R01
1.191	0.0469	R0	X3/64	R0310	1191	UL1505	R0	2½C	RI-2½	R0
1.397	0.0550	R1	R1	R0412	1397	R1706	R1	3C	RI-3	R1
1.984	0.0781	R1-4	X5/64	R0516	BR5/64	R2508	R1-4	4C	RI-4	R1-4
2.380	0.0937	R133 R1-5	AX3/32 X3/32	R0612 R620	2380 BR3/32	UL3006 R3010	R133 R1-5	3332C 5C	RI-3332 RI-5	R133 R1-5
3.175	0.1250	R144 R2-5 R2-6  R2 R2A	AX1/8 X1/8 —  R2 R2A	R0816 R820 R824  R2 R2A	3175 BR1/8A BR1/8A/6  BR1/8B BR1/8B/083	UL4008 R4010 —  R4012 —	R144 R2-5 R2-6  R2 R2A	418C 518C 618C  R2C R2AC	RI-418 RI-518 RI-618  R-2 —	R144 R2-5 R2-6  R2 RA2
3.967	0.1562	R155	X5/32	R1020	3967	UL5010	R155	5532C	RI-5532	R155
4.762	0.1875	R156 R166 R3	AX3/16 X3/16 Y3/16	R1220 R1224 R3	4763A 4763B BR3/16	UL6010 UL6012 R6016	R156 R166 R3	5632C 6316C R3C	RI-5632 RI-6632 R-3	R156 R166 R3
6.350	0.2500	R168 R188 R4B R4AA	X1/4 R188 Y1/4 R4A	R1624 R1632 R4 R4A	6350A 6350B BR1/4A BR1/4	UL8012 UL8016 R8020 —	R168 R188 R4 R4A	614C 814C R4C R4AR	RI-614 RI-814 R-4 RI-1214	R168 R188 R4 —
7.938	0.3125	R1810	—	R2032	7938	—	R1810	8516C	RI-8516	—
9.525	0.3750	R6	Y3/8	R6	BR3/8	—	R6	R6R	RI-1438	—
In case of stainless steel		S ———	W ———	S ———	S ———	——— X	S ———	S ———	SS ———	F ———

**Conversion Table 6**  
Deep groove ball bearings  
Shielded type (Inch series)

Bore diameter d		NSK	ADR	FAG	GRW	RMB	BARDEN	MPB	NMB	NTN
mm	inch									
1.191	0.0469	R0ZZ	X3/64ZZ	R0310.2Z	1191-2Z	ULZ1505	R0SS	2½CHH	RI-2½ZZ	RA0ZZA
1.397	0.0550	R1ZZ	R1ZZ	R0412.2Z	1397-2Z	RF1706	R1S	3CHH	RI-3ZZ	RA1ZZ1
1.984	0.0781	R1-4ZZ	X5/64ZZ	R0516.2Z	BR5/64-2Z	RF2508	R1-4SS	4CHH	RI-4ZZ	RA1-4ZZ1
2.380	0.0937	R133ZZS R1-5ZZ	AX3/32ZZ X3/32ZZ	R0612.2Z R620.2Z	2380-2Z BR3/32ZZ	ULZ3006 RF3010	R133SS R1-5SS	3332CHH 5CHH	RI-3332ZZ RI-5ZZ	RA133ZZA RA1-5ZZA
3.175	0.1250	R144ZZ R2-5ZZ R2-6ZZS  R2ZZ R2AZZ	AX1/8ZZ X1/8ZZ —  R2ZZ R2AZZ	R0816.2Z R820.2Z R824.2Z  R2.2Z R2A.2Z	3175-2Z BR1/8A-2Z BR1/8A/6-2Z  BR1/8B-2Z BR1/8B/083-2Z	ULZ4008 RF4010 —  RF4012 —	R144SS R2-5SS R2-6SS  R2SS R2ASS	418CHH 518CHH 618CHH  R2CHH R2ACHH	RI-418ZZ RI-518ZZ RI-618ZZ  R-2ZZ —	RA144ZZA RA2-5ZZA RA2-6ZZA  R2ZZA RA2ZZA
3.967	0.1562	R155ZZS	X5/32ZZ	R1020.2Z	3967-2Z	ULZ5010	R155SS	5532CHH	RI-5532ZZ	RA155ZZA
4.762	0.1875	R156ZZS R166ZZ R3ZZ	AX3/16ZZ X3/16ZZ Y3/16ZZ	R1220.2Z R1224.2Z R3.2Z	4763A-2Z 4763B-2Z BR3/16-2Z	ULZ6010 ULZ6012 RF6016	R156SS R166SS R3SS	5632CHH 6316CHH R3CHH	RI-5632ZZ RI-6632ZZ R-3ZZ	RA156ZZA RA166ZZA RA3ZZA
6.350	0.2500	R168ZZ R188ZZ R4BZZ R4AAZZ	X1/4ZZ R188ZZ Y1/4ZZ R4AZZ	R1624.2Z R1632.2Z R4.2Z R4A.2Z	6350A-2Z 6350B-2Z BR1/4A-2Z BR1/4-2Z	ULZ8012 ULZ8016 RF8020 —	R168SS R188SS R4SS R4ASS	614CHH 814CHH R4CHH R4ARHH	RI-614ZZ RI-814ZZ R-4ZZ RI-1214ZZ	R168ZZA R188ZZA R4ZZ RA4ZZ
7.938	0.3125	R1810ZZ	—	R2032.2Z	7938-2Z	—	R1810SS	8516CHH	RI-8516ZZ	—
9.525	0.3750	R6ZZ	Y3/8ZZ	R6.2Z	BR3/8-2Z	—	R6SS	R6RHH	RI-1438ZZ	R6ZZ
In case of stainless steel		S ———	W ———	S ———	S ———	——— X	S ———	S ———	SS ———	F ———

**Conversion Table 7**  
Deep groove ball bearings with flanged outer ring  
Open type (Inch series)

Bore diameter d		NSK	ADR	FAG	GRW	RMB	BARDEN	MPB	NMB	NTN
mm	inch									
1.191	0.0469	FR0	FX3/64	RF0310	F1191	ULK1505	FR0	2½FC	RIF-2½	FLR0
1.397	0.0550	FR1	FR1	RF0412	F1397	RK1706	FR1	3FC	RIF-3	FLR1
1.984	0.0781	FR1-4	FX5/64	RF0516	F5/64	RK2508	FR1-4	4FC	RIF-4	FLR1-4
2.380	0.0937	FR133 FR1-5	FAX3/32 FX3/32	RF0612 RF620	F2380 F3/32	ULK3006 RK3010	FR133 FR1-5	3332FC 5FC	RIF-3332 RIF-5	FLR133 FLR1-5
3.175	0.1250	FR144 FR2-5 FR2-6  FR2	FAX1/8 FX1/8 —  FR2	RF0816 RF820 RF824 RF2	F3175 F1/8A F1/8A/6 F1/88	ULK4008 RK4010 — RK4012	FR144 FR2-5 FR2-6 FR2	418FC 518FC 618FC R2FC	RIF-418 RIF-518 RIF-618 RF-2	RIF-144 FLR2-5 FLR2-6 FLR2
3.967	0.1562	FR155	FX5/32	RF1020	F3967	ULK5010	FR155	5532FC	RIF-5532	FLR155
4.762	0.1875	FR156 FR166 FR3	FAX3/16 FX3/16 FY3/16	RF1220 RF1224 RF3	F4763A F4763B —	ULK6010 ULK6012 RK6016	FR156 FR166 FR3	5632FC 6316FC —	RIF-5632 RIF-6632 —	FLR156 FLR166 FLR3
6.350	0.2500	FR168 FR188 FR4B	FX1/4 FR188 FY1/4	RF1624 RF1632 RF4	F6350A F6350B F1/4A	ULK8012 ULK8016 RK8020	FR168 FR188 FR4	614FC 814FC R4FC	RIF-614 RIF-814 RF-4	FLR168 FLR188 FLR4
7.938	0.3125	FR1810	—	RF2032	F7938	—	FR1810	8516FC	RIF-8516	—
9.525	0.3750	FR6	—	—	—	—	—	—	—	—
In case of stainless steel		S ———	W ———	S ———	S ———	——— X	S ———	S ———	SS ———	F ———

**Conversion Table 8**  
Deep groove ball bearings with flanged outer ring  
Shielded type (Inch series)

Bore diameter d		NSK	ADR	FAG	GRW	RMB	BARDEN	MPB	NMB	NTN
mm	inch									
1.191	0.0469	FR0ZZ	FX3/64ZZ	RF0310.2Z	F1191-2Z	ULKZ1505	FR0SS	2½FCHH	RIF-2½ZZ	FLRA0ZZA
1.397	0.0550	FR1ZZ	FR1ZZ	RF0412.2Z	F1397-2Z	RKF1706	FR1SS	3FCHH	RIF-3ZZ	FLRA1ZZA
1.984	0.0781	FR1-4ZZ	FX5/64ZZ	RF0516.2Z	F5/64-2Z	RKF2508	FR1-4SS	4FCHH	RIF-4ZZ	FLRA1-4ZZA
2.380	0.0937	FR133ZZS FR1-5ZZ	FAX3/32ZZ FX3/32ZZ	RF0612.2Z RF620.2Z	F2380-2Z F3/32-2Z	ULKZ3006 RKF3010	FR133SS FR1-5SS	3332FCHH 5FCHH	RIF-3332ZZ RIF-5ZZ	FLRA133ZZAS FLRA1-5ZZA
3.175	0.1250	FR144ZZ FR2-5ZZ FR2-6ZZS  FR2ZZ	FAX1/8ZZ FX1/8ZZ —  FR2ZZ	RF0816.2Z RF820.2Z RF824.2Z RF2.2Z	F3175-2Z F1/8A-2Z F1/8A/6-2Z F1/88-2Z	ULKZ4008 RKF4010 — RKF4012	FR144SS FR2-5SS FR2-6SS FR2SS	418FCHH 518FCHH 618FCHH R2FCHH	RIF-418ZZ RIF-518ZZ RIF-618ZZ RF-2ZZ	FLRA144ZZA FLRA2-5ZZA FLRA2-6ZZAS FLR2ZZA
3.967	0.1562	FR155ZZS	FX5/32ZZ	RF1020.2Z	F3967-2Z	ULKZ5010	FR155SS	5532FCHH	RIF-5532ZZ	FLRA155ZZAS
4.762	0.1875	FR156ZZS FR166ZZ FR3ZZ	FAX3/16ZZ FX3/16ZZ FY3/16ZZ	RF1220.2Z RF1224.2Z RF3.2Z	F4763A-2Z F4763B-2Z F3/16-2Z	ULKZ6010 ULKZ6012 RKF6016	FR156SS FR166SS FR3SS	5632FCHH 6316FCHH R3FCHH	RIF-5632ZZ RIF-6632ZZ RF-3ZZ	FLRA156ZZAS FLRA166ZZA FLRA3ZZA
6.350	0.2500	FR168ZZ FR188ZZ FR4BZZ	FX1/4ZZ FR188ZZ FY1/4ZZ	RF1624.2Z RF1632.2Z RF4.2Z	F6350A-2Z F6350B-2Z F1/4A-2Z	ULKZ8012 ULKZ8016 RKF8020	FR168SS FR188SS FR4SS	614FCHH 814FCHH R4FCHH	RIF-614ZZ RIF-814ZZ RF-4ZZ	FLRA168ZZA FLRA188ZZA FLR4ZZA
7.938	0.3125	FR1810ZZ	—	RF2032.2Z	F7938-2Z	—	FR1810SS	8516FCHH	RIF-8516ZZ	—
9.525	0.3750	FR6ZZ	FY3/8ZZ	RF6.2Z	—	—	FR6SS	R6FRHH	RIF-1438ZZ	FLR6ZZ
In case of stainless steel		S ———	W ———	S ———	S ———	——— X	S ———	S ———	F ———	SS ———

**Conversion Table 9**  
**Deep groove ball bearings with extended inner ring**  
**Open type (Inch series)**

Bore diameter d		NSK	ADR	FAG	GRW	RMB	BARDEN	MPB	NMB	NTN
mm	inch									
1.191	0.0469	RW0	LX3/64	RE0310	E1191	ULU1505	RW0	2½CE	RI-2½EE	RW0
1.397	0.0550	RW1	LR1	RE0412	E1397	RU1706	RW1	3CE	RI-3EE	RW1
1.984	0.0781	RW1-4	LX5/64	RE0516	E5/64	—	RW1-4	4CE	RI-4EE	RW1-4
2.380	0.0937	RW133 RW1-5	LAX3/32 LX3/32	RE0612 RE620	E2380 E3/32	ULU3006 RU3010	RW133 RW1-5	3332CE 5CE	RI-3332EE RI-5EE	RW133 RW1-5
3.175	0.1250	RW144 RW2-5 RW2-6 RW2	LAX1/8 LX1/8 — LR2	RE0816 RE820 RE824 RE2	E3175 E1/8A E1/8A/6 E1/8B	ULU4008 RU4010 — —	RW144 RW2-5 RW2-6 RW2	418CE 518CE 618CE R2CE	RI-418EE RI-518EE RI-618EE R-2EE	RW144 RW2-5 RW2-6 RW2
3.967	0.1562	RW155	LX5/32	RE1020	E3967	—	RW155	5532CE	RI-5532EE	RW155
4.762	0.1875	RW156 RW166	LAX3/16 LX3/16	RE1220 RE1224	E4763A E4763B	ULU6010 ULU6012	RW156 RW166	5632CE 6316CE	RI-5632EE RI-6632EE	RW156 RW166
6.350	0.2500	RW168 RW188	LX1/4 LR188	RE1624 RE1632	E6350A E6350B	ULU8012 —	RW168 RW188	614CE 814CE	RI-614EE RI-814EE	RW168 RW188
7.938	0.3125	RW1810	—	RE2032	E7938	—	RW1810	8516CE	RI-8516EE	—
In case of stainless steel		S	W	S	S	— X	S	S	SS	F

**Conversion Table 10**  
**Deep groove ball bearings with extended inner ring**  
**Shielded type (Inch series)**

Bore diameter d		NSK	ADR	FAG	GRW	RMB	BARDEN	MPB	NMB	NTN
mm	inch									
1.191	0.0469	RW0ZZ	LX3/64ZZ	RE0310.2Z	E1191-2Z	—	—	2½CHHE	RI-2½ZZEE	RAW0ZZA
1.397	0.0550	RW1ZZ	LR1ZZ	RE0412.2Z	E1397-2Z	—	—	3CHHE	RI-3ZZEE	RAW1ZZA
1.984	0.0781	RW1-4ZZ	LX5/64ZZ	RE0516.2Z	E5/64-2Z	—	RW1-4SS	4CHHE	RI-4ZZEE	RAW1-4ZZA
2.380	0.0937	RW133ZZS RW1-5ZZ	LAX3/32ZZ LX3/32ZZ	RE0612.2Z RE620.2Z	E2380-2Z E3/32-2Z	—	RW133SS RW1-5SS	3332CHHE 5CHHE	RI-3332ZZEE RI-5ZZEE	RAW133ZZA RAW1-5ZZA
3.175	0.1250	RW144ZZ RW2-5ZZ RW2-6ZZ RW2ZZ	LAX1/8ZZ LX1/8ZZ — LR2ZZ	RE0816.2Z RE820.2Z RE824.2Z RE2.2Z	E3175-2Z E1/8A-2Z E1/8A/6-2Z E1/8B-2Z	ULUZ4008 — — —	RW144SS RW2-5SS RW2-6SS RW2SS	418CHHE 518CHHE 618CHHE R2CHHE	RI-418ZZEE RI-518ZZEE RI-618ZZEE R-2ZZEE	RAW144ZZA RAW2-5ZZA RAW2-6ZZA RAW2ZZA
3.967	0.1562	RW155ZZS	LX5/32ZZ	RE1020.2Z	E3967-2Z	ULUZ5010	RW155SS	5532CHHE	RI-5532ZZEE	RAW155ZZA
4.762	0.1875	RW156ZZS RW166ZZ	LAX3/16ZZ LX3/16ZZ	RE1220.2Z RE1224.2Z	E4763A-2Z E4763B-2Z	ULUZ6010 ULUZ6012	RW156SS RW166SS	5632CHHE 6316CHHE	RI-5632ZZEE RI-6632ZZEE	RAW156ZZA RAW166ZZA
6.350	0.2500	RW168ZZ RW188ZZ	LX1/4ZZ LR188ZZ	RE1624.2Z RE1632.2Z	E6350A-2Z E6350B-2Z	ULUZ8012 —	RW168SS RW188SS	614CHHE 814CHHE	RI-614ZZEE RI-814ZZEE	RAW168ZZA RAW188ZZA
7.938	0.3125	RW1810ZZ	—	RE2032.2Z	E7938-2Z	—	RW1810SS	8516CHHE	RI-8516ZZEE	—
In case of stainless steel		S	W	S	S	— X	S	S	SS	F

**Conversion Table 11**  
**Deep groove ball bearings with extended inner ring,**  
**Flanged, open type (Inch series)**

Bore diameter d		NSK	ADR	FAG	GRW	RMB	BARDEN	MPB	NMB	NTN
mm	inch									
1.191	0.0469	FRW0	FLX3/64	RFE0310	FE1191	ULKU1505	FRW0	2½FCE	RIF-2½EE	FLRW0
1.397	0.0550	FRW1	FLR1	RFE0412	FE1397	RKU1706	FRW1	3FCE	RIF-3EE	FLRW1
1.984	0.0781	FRW1-4	FLX5/64	RFE0516	FE5/64	—	FRW1-4	4FCE	RIF-4EE	FLRW1-4
2.380	0.0937	FRW133 FRW1-5	FLAX3/32 FLX3/32	RFE0612 RFE620	FE2380 FE3/32	ULKU3006 RKU3010	FRW133 FRW1-5	3332FCE 5FCE	RIF-3332EE RIF-5EE	FLRW133 FLRW1-5
3.175	0.1250	FRW144 FRW2-5 FRW2-6 FRW2	FLAX1/8 FLX1/8 — FLR2	RFE0816 RFE820 RFE824 RFE2	FE3175 FE1/8A FE1/8A/6 FE1/8B	ULKU4008 RKU4010 — —	FRW144 FRW2-5 FRW2-6 FRW2	418FCE 518FCE 618FCE R2FCE	RIF-418EE RIF-518EE RIF-618EE RIF-2EE	FLRW144 FLRW2-5 FLRW2-6 FLRW2
3.967	0.1562	FRW155	FLX5/32	RFE1020	FE3967	—	FRW155	5532FCE	RIF-5532EE	FLRW155
4.762	0.1875	FRW156 FRW166	FLAX3/16 FLX3/16	RFE1220 RFE1224	FE4763A FE4763B	ULKU6010 ULKU6012	FRW156 FRW166	5632FCE 6316FCE	RIF-5632EE RIF-6632EE	FLRW156 FLRW166
6.350	0.2500	FRW168 FRW188	FLX1/4 FLR188	RFE1624 RFE1632	FE6350A FE6350B	ULKU8012 —	FRW168 FRW188	614FCE 814FCE	RIF-614EE RIF-814EE	FLRW168 FLRW188
7.938	0.3125	FRW1810	—	RFE2032	FE7938	—	FRW1810	8516FCE	RIF-8516EE	—
In case of stainless steel		S	W	S	S	— X	S	S	SS	F

**Conversion Table 12**  
**Deep groove ball bearings with extended inner ring,**  
**Flanged, shielded type (Inch series)**

Bore diameter d		NSK	ADR	FAG	GRW	RMB	BARDEN	MPB	NMB	NTN
mm	inch									
1.191	0.0469	FRW0ZZ	FLX3/64ZZ	RFE0310.2Z	FE1191-2Z	—	—	2½FCHHE	RIF-2½ZZEE	FLRAW0ZZA
1.397	0.0550	FRW1ZZ	FLR1ZZ	RFE0412.2Z	FE1397-2Z	—	—	3FCHHE	RIF-3ZZEE	FLRAW1ZZA
1.984	0.0781	FRW1-4ZZ	FLX5/64ZZ	RFE0516.2Z	FE5/64-2Z	—	FRW1-4SS	4FCHHE	RIF-4ZZEE	FLRAW1-4ZZA
2.380	0.0937	FRW133ZZS FRW1-5ZZ	FLAX3/32ZZ FLX3/32ZZ	RFE0612.2Z RFE620.2Z	FE2380-2Z FE3/32-2Z	—	FRW133SS FRW1-5SS	3332FCHHE 5FCHHE	RIF-3332ZZEE RIF-5ZZEE	FLRAW133ZZA FLRAW1-5ZZA
3.175	0.1250	FRW144ZZ FRW2-5ZZ FRW2-6ZZ FRW2ZZ	FLAX1/8ZZ FLX1/8ZZ — FLR2ZZ	RFE0816.2Z RFE820.2Z RFE824.2Z RFE2.2Z	FE3175-2Z FE1/8A-2Z FE1/8A/6-2Z FE1/8B-2Z	ULKUZ4008 — — —	FRW144SS FRW2-5SS FRW2-6SS FRW2SS	418FCHHE 518FCHHE 618FCHHE R2FCHHE	RIF-418ZZEE RIF-518ZZEE RIF-618ZZEE RIF-2ZZEE	FLRAW144ZZA FLRAW2-5ZZA FLRAW2-6ZZA FLRAW2ZZA
3.967	0.1562	FRW155ZZS	FLX5/32ZZ	RFE1020.2Z	FE3967-2Z	ULKUZ5010	FRW155SS	5532FCHHE	RIF-5532ZZEE	FLRAW155ZZA
4.762	0.1875	FRW156ZZS FRW166ZZ	FLAX3/16ZZ FLX3/16ZZ	RFE1220.2Z RFE1224.2Z	FE4763A-2Z FE4763B-2Z	ULKUZ6010 ULKUZ6012	FRW156SS FRW166SS	5632FCHHE 6316FCHHE	RIF-5632ZZEE RIF-6632ZZEE	FLRAW156ZZA FLRAW166ZZA
6.350	0.2500	FRW168ZZ FRW188ZZ	FLX1/4ZZ FLR188ZZ	RFE1624.2Z RFE1632.2Z	FE6350A-2Z FE6350B-2Z	ULKUZ8012 —	FRW168SS FRW188SS	614FCHHE 814FCHHE	RIF-614ZZEE RIF-814ZZEE	FLRAW168ZZA FLRAW188ZZA
7.938	0.3125	FRW1810ZZ	—	RFE2032.2Z	FE7938-2Z	—	FRW1810SS	8516FCHHE	RIF-8516ZZEE	—
In case of stainless steel		S	W	S	S	— X	S	S	SS	F





# Worldwide Sales Offices and Manufacturing Plants

P: Phone F: Fax C: Country Code Printed in Japan

## Taiwan:

### TAIWAN NSK PRECISION CO., LTD.

TAIPEI 11F., No.87, Song Jiang Rd., Jhongshan District, Taipei City 104, Taiwan R.O.C.  
P: 02-2509-3305 F: 02-2509-1393 C: 886

TAICHUNG 107-7, Sec. 3, Wen Xing Rd., Taichung City 407, Taiwan R.O.C.  
P: 04-2311-7978 F: 04-2311-2627 C: 886

TAINAN No.8 Daye 1st Rd., Southern Taiwan Science Park, Tainan County 741, Taiwan R.O.C.  
P: 06-505-5861 F: 06-505-5061 C: 886

### TAIWAN NSK TECHNOLOGY CO., LTD.

TAIPEI 11F., No. 87, Songjiang Rd., Jhongshan District, Taipei City 104, Taiwan R.O.C.  
P: 02-2509-3305 F: 02-2509-1393 C: 886

TAICHUNG 10F-3, No.123, Sec.3, Junggang Rd., Taichung 407, Taiwan R.O.C.  
P: 04-2358-2945 F: 04-2358-7682 C: 886

TAINAN 5F, No.8, Daye 1st Rd., Southern Taiwan Science Park, Tainan County 741, Taiwan R.O.C.  
P: 06-505-5861 F: 06-505-5061 C: 886

## Thailand:

### NSK BEARINGS (THAILAND) CO.,LTD.

BANGKOK 26 Soi On-Nuch 55/1 Pravet District, Bangkok 10250, Thailand  
P: 02320-2555 F: 02320-2826 C: 66

### NSK BEARINGS MANUFACTURING (THAILAND) CO., LTD.

OFFICE/PLANT 700/430 Moo 7, Amata Nakorn Industrial Estate, T.Donhualor, A.Muangchonburi, Chonburi 20000, Thailand  
P: 038-454-010 F: 038-454-017 C: 66

### SIAM NSK STEERING SYSTEMS CO., LTD.

OFFICE/PLANT 90 Moo 9, Wellgrow Industrial Estate, Km.36 Bangna-Trad Rd., Bangwao, Bangkok, Chachoengsao 24180, Thailand  
P: 038-522-343 F: 038-522-351 C: 66

### NSK ASIA PACIFIC TECHNOLOGY CENTRE (THAILAND) CO., LTD.

CHONBURI 700/430 Moo 7, Amata Nakorn Industrial Estate, T.Donhualor, A.Muangchonburi, Chonburi 20000, Thailand  
P: 038-454-631 F: 038-454-634 C: 66

## Vietnam:

### NSK VIETNAM CO., LTD.

HEAD OFFICE Techno Center, Room 204-205, Thang Long Industrial Park, Dong Anh District, Hanoi, Vietnam  
P: 04-3955-0159 F: 04-3955-0158 C: 84

### NSK REPRESENTATIVE OFFICE

HO CHI MINH CITY Suite 307, Metropolitan Building, 235 Dong Khoi Street, District 1, HCMC, Vietnam  
P: 08-3822-7907 F: 08-3822-7910 C: 84

## Europe

### NSK EUROPE LTD. (EUROPEAN HEADQUARTERS) [www.eu.nsk.com](http://www.eu.nsk.com)

MAIDENHEAD Belmont Place, Belmont Road, Maidenhead, Berkshire SL6 6TB, U.K.  
P: 01628-509-800 F: 01628-509-808 C: 44

## France:

### NSK FRANCE S.A.S.

PARIS Quartier de l'Europe, 2 Rue Georges Guynemer, 78283 Guyancourt, France  
P: 01-30-57-39-39 F: 01-30-57-00-01 C: 33

## Germany:

### NSK DEUTSCHLAND GMBH

HEAD OFFICE Harkortstrasse 15, D-40880 Ratingen, Germany  
P: 02102-4810 F: 02102-4812-290 C: 49

STUTTGART Liebknechtstrasse 33, D-70565 Stuttgart-Vaihingen, Germany  
P: 0711-79082-0 F: 0711-79082-289 C: 49

WOLFSBURG Heinrich-Nordhoff-Strasse 101, D-38440 Wolfsburg, Germany  
P: 05361-27647-10 F: 05361-27647-70 C: 49

### NEUWEG FERTIGUNG GMBH

OFFICE/PLANT Ehinger Strasse 5, D-89597 Munderkingen, Germany  
P: 07393-540 F: 07393-5414 C: 49

## Italy:

### NSK ITALIA S.P.A.

MILANO Via Garibaldi 215, Garbagnate Milanese (Milano) 20024, Italy  
P: 0299-5191 F: 0299-025778 C: 39

## Netherlands:

### NSK EUROPEAN DISTRIBUTION CENTRE B.V.

De Kroonstraat 38, 5048 AP Tilburg, Netherlands  
P: 013-4647647 F: 013-4647648 C: 31

## Poland:

### NSK EUROPE LTD. REPRESENTATIVE OFFICE

WARSAW Ul. Migdalowa 4/73, 02-796, Warsaw, Poland  
P: 022-645-1525 F: 022-645-1529 C: 48

### NSK BEARINGS POLSKA S.A.

OFFICE/PLANT Ul. Jagiellonska 109, 25-734 Kielce, Poland  
P: 041-366-5001 F: 041-367-0500 C: 48

### NSK EUROPEAN TECHNOLOGY CENTER, POLAND OFFICE

Ul. Jagiellonska 109, 25-734 Kielce, Poland  
P: 041-367-0940 F: 041-367-0930 C: 48

### NSK STEERING SYSTEMS EUROPE (POLSKA) SP.ZO.O.

CORPORATE Ul. Mariana Jachimowicza 17, 58-306 Walbrzych, Poland  
OFFICE/PLANT P: 074-664-4101 F: 074-664-4104 C: 48

### NSK NEEDLE BEARING POLAND SP.ZO.O.

OFFICE/PLANT Ul. Jagiellonska 109, 25-734 Kielce, Poland  
P: 041-345-2469 F: 041-345-0361 C: 48

### NSK POLSKA SP.ZO.O.

KIELCE Ul. Karczowkowska 41, 25-711 Kielce, Poland  
P: 041-347-5110 F: 041-347-5101 C: 48

## Spain:

### NSK SPAIN S.A.

BARCELONA C/Tarragona 161, 2a Planta, 08014, Barcelona, Spain  
P: 093-433-5775 F: 093-433-5776 C: 34

## Turkey:

### NSK RULMANLARI ORTA DOGU TIC. LTD. STI.

ISTANBUL 19 Mayıs Mah. Atatürk Cad. Ulya Engin Is Merkezi No. 68 Kat. 6, Kozyatagi 34734, Istanbul, Turkey  
P: 0216-355-0398 F: 0216-355-0399 C: 90

## United Kingdom:

### NSK BEARINGS EUROPE LTD.

PETERLEE 3 Brindley Road, South West Industrial Estate, Peterlee, Co. Durham SR8 2JD, U.K.  
PLANT P: 0191-586-6111 F: 0191-586-3482 C: 44

NEWARK Northern Road, Newark, Nottinghamshire NG24 2JF, U.K.  
PLANT P: 01636-605-123 F: 01636-605-000 C: 44

### NSK EUROPEAN TECHNOLOGY CENTRE

NEWARK Northern Road, Newark, Nottinghamshire NG24 2JF, U.K.  
P: 01636-605-123 F: 01636-643-241 C: 44

### NSK UK LTD.

NEWARK Northern Road, Newark, Nottinghamshire NG24 2JF, U.K.  
P: 01636-605-123 F: 01636-605-000 C: 44

### NSK PRECISION UK LTD.

PLANT Northern Road, Newark, Nottinghamshire NG24 2JF, U.K.  
P: 01636-605-123 F: 01636-605-000 C: 44

### NSK STEERING SYSTEMS EUROPE LTD.

HEAD OFFICE Belmont Place, Belmont Road, Maidenhead, Berkshire SL6 6TB, U.K.  
P: 01628-509-800 F: 01628-509-808 C: 44

PETERLEE 6/7 Doxford Drive, South West Industrial Estate, Peterlee, Co. Durham SR8 2PP, U.K.  
PLANT P: 0191-518-6400 F: 0191-518-6421 C: 44

## North and South America

### NSK AMERICAS, INC. (AMERICAN HEADQUARTERS)

ANN ARBOR 4200 Goss Road, Ann Arbor, Michigan 48105, U.S.A.  
P: 734-913-7500 F: 734-913-7511 C: 1

## Argentina:

### NSK ARGENTINA SRL

BUENOS AIRES Garcia del Rio 2477 Piso 7 Oficina "A" (1429) Buenos Aires-Argentina  
P: 11-4704-5100 F: 11-4704-0033 C: 54

## Brazil:

### NSK BRASIL LTDA. [www.br.nsk.com](http://www.br.nsk.com)

HEAD OFFICE Rua 13 de Maio, 1633-14th Andar-Bela Vista-CEP 01327-905 São Paulo, SP, Brazil  
P: 011-3269-4786 F: 011-3269-4720 C: 55

SUZANO PLANT Av. Vereador Joao Batista Fitipaldi, 66, CEP 08685-000, Vila Maluf, Suzano, SP, Brazil  
P: 011-4744-2527 F: 011-4744-2529 C: 55

BELO HORIZONTE Rua Ceara 1431-4th andar-sala 405-Funcionarios Belo Horizonte-MG, Brazil 30150-311  
P: 031-3274-2591 F: 031-3273-4408 C: 55

JOINVILLE Rua Blumenau, 178-sala 910-Centro Joinville-SC, Brazil 89204-250  
P: 047-3422-5445 F: 047-3422-2817 C: 55

PORTO ALEGRE Av. Cristovão Colombo, 1694-sala 202-Floresta Porto Alegre-RS, Brazil 90560 001  
P: 051-3222-1324 F: 051-3222-2599 C: 55

RECIFE Av. Conselheiro Aguiar, 2738-6th andar-conj. 604-Boa Viagem Recife-PE, Brazil 51020-020  
P: 081-3326-3781 F: 081-3326-5047 C: 55

## Peru:

### NSK PERU S.A.C.

LIMA Av. Caminos del Inca 670, Ofic : # 402, Santiago del Surco, Lima, Perú  
P: 01-652-3372 F: 01-638-0555 C: 51

## Canada:

### NSK CANADA INC. [www.ca.nsk.com](http://www.ca.nsk.com)

HEAD OFFICE 5585 McAdam Road, Mississauga, Ontario, Canada L4Z 1N4  
P: 905-890-0740 F: 800-800-2788 C: 1

TORONTO 5585 McAdam Road, Mississauga, Ontario, Canada L4Z 1N4  
P: 877-994-6675 F: 800-800-2788 C: 1

MONTREAL 2150-32E Avenue Lachine, Quebec, Canada H8T 3H7  
P: 514-633-1220 F: 800-800-2788 C: 1

VANCOUVER 3353 Wayburne Drive, Burnaby, British Columbia, Canada V5G 4L4  
P: 877-994-6675 F: 800-800-2788 C: 1

## Mexico:

### NSK RODAMIENTOS MEXICANA, S.A. DE C.V. [www.mx.nsk.com](http://www.mx.nsk.com)

MEXICO CITY Av. Presidente Juarez No.2007 Lote 5, Col. San Jeronimo Tepetlacaol, Tlalhepantla, Estado de Mexico, Mexico, C.P.54090  
P: 55-3682-2900 F: 55-3682-2937 C: 52

MONTERREY Av. Ricardo Margain 575, IOS Torre C, Suite 516, Parque Corporativo Santa Engracia, San Pedro Garza Garcia, N.L. Mexico, C.P.66267  
P: 81-8000-7300 F: 81-8000-7095 C: 52

## United States of America:

### NSK CORPORATION [www.us.nsk.com](http://www.us.nsk.com)

HEAD OFFICE 4200 Goss Road, Ann Arbor, Michigan 48105, U.S.A.  
P: 734-913-7500 F: 734-913-7511 C: 1

NSK AMERICAN TECHNOLOGY CENTER 4200 Goss Road, Ann Arbor, Michigan 48105, U.S.A.  
P: 734-913-7500 F: 734-913-7511 C: 1

CLARINDA PLANT 1100 N. First Street, Clarinda, Iowa 51632, U.S.A.  
P: 712-542-5121 F: 712-542-4905 C: 1

FRANKLIN PLANT 3400 Bearing Drive, Franklin, Indiana 46131, U.S.A.  
P: 317-738-5000 F: 317-738-5064 C: 1

LIBERTY PLANT 1112 East Kitchel Road, Liberty, Indiana 47353, U.S.A.  
P: 765-458-5000 F: 765-458-7832 C: 1

### NSK PRECISION AMERICA, INC. [www.npa.nsk.com](http://www.npa.nsk.com)

OFFICE/PLANT 3450 Bearing Drive, Franklin, Indiana 46131, U.S.A.  
P: 317-738-5000 F: 317-738-5050 C: 1

SAN JOSE 780 Montague Expressway, Suite 508, San Jose, California 95131, U.S.A.  
P: 408-944-9400 F: 408-944-9405 C: 1

### NSK STEERING SYSTEMS AMERICA, INC. [www.nssa.nsk.com](http://www.nssa.nsk.com)

OFFICE/PLANT 110 Shields Drive, Bennington, Vermont 05201, U.S.A.  
P: 802-442-5448 F: 802-442-2253 C: 1

DYERSBURG PLANT 2962 Fort Hudson Road, Dyersburg, TN 38204, U.S.A.  
P: 731-288-3000 F: 731-288-3001 C: 1

ANN ARBOR 4200 Goss Road, Ann Arbor, Michigan 48105, U.S.A.  
P: 734-913-7500 F: 734-913-7102 C: 1

### NSK-WARNER U.S.A., INC.

TROY 3001 West Big Beaver Road, Suite 701, Troy, Michigan 48084, U.S.A.  
P: 248-822-8888 F: 248-822-1111 C: 1

### NSK LATIN AMERICA, INC. [www.la.nsk.com](http://www.la.nsk.com)

MIAMI 2500 NW 107th Avenue, Suite 300, Miami, Florida 33172, U.S.A.  
P: 305-477-0605 F: 305-477-0377 C: 1

<As of August 2011>

For the latest information, please refer to the NSK website.

NSK Ltd. has a basic policy not to export any products or technology designated as controlled items by export-related laws. When exporting the products in this brochure, the laws of the exporting country must be observed. Specifications are subject to change without notice and without any obligation on the part of the manufacturer. Every care has been taken to ensure the accuracy of the data contained in this brochure, but no liability can be accepted for any loss or damage suffered through errors or omissions. We will gratefully acknowledge any additions or corrections.



NSK used environmentally friendly printing methods for this publication.

CAT. NO. E126h 2011 B-11 Printed in Japan ©NSK Ltd. 2011